

Notice for TAIYO YUDEN Products

Please read this notice before using the TAIYO YUDEN products.

⚠ REMINDERS

Product Information in this Catalog

Product information in this catalog is as of March 2023. All of the contents specified herein and production status of the products listed in this catalog are subject to change without notice due to technical improvement of our products, etc. Therefore, please check for the latest information carefully before practical application or use of our products.

Please note that TAIYO YUDEN shall not be in any way responsible for any damages and defects in products or equipment incorporating our products, which are caused under the conditions other than those specified in this catalog or individual product specification sheets.

Approval of Product Specifications

Please contact TAIYO YUDEN for further details of product specifications as the individual product specification sheets are available. When using our products, please be sure to approve our product specifications or make a written agreement on the product specification with TAIYO YUDEN in advance.

Pre-Evaluation in the Actual Equipment and Conditions

Please conduct validation and verification of our products in actual conditions of mounting and operating environment before using our products.

Limited Application

1. Equipment Intended for Use

The products listed in this catalog are intended for general-purpose and standard use in general electronic equipment for consumer (e.g., AV equipment, OA equipment, home electric appliances, office equipment, information and communication equipment including, without limitation, mobile phone, and PC) and other equipment specified in this catalog or the individual product specification sheets, or the equipment approved separately by TAIYO YUDEN.

TAIYO YUDEN has the product series intended for use in the following equipment. Therefore, when using our products for these equipment, please check available applications specified in this catalog or the individual product specification sheets and use the corresponding products.

Application	Product Series		Quality Grade ^{*3}
	Equipment ^{*1}	Category (Part Number Code ^{*2})	
Automotive	Automotive Electronic Equipment (POWERTRAIN, SAFETY)	A	1
	Automotive Electronic Equipment (BODY & CHASSIS, INFOTAINMENT)	C	2
Industrial	Telecommunications Infrastructure and Industrial Equipment	B	2
Medical	Medical Devices classified as GHTF Class C (Japan Class III)	M	2
	Medical Devices classified as GHTF Classes A or B (Japan Classes I or II)	L	3
Consumer	General Electronic Equipment	S	3
	Only for Mobile Devices ^{*4}	E	4

*Notes: 1. Based on the general specifications required for electronic components for such equipment, which are recognized by TAIYO YUDEN, the use of each product series for the equipment is recommended. Please be sure to contact TAIYO YUDEN before using our products for equipment other than those covered by the product series.

2. On each of our part number, the 2nd code from the left is a code indicating the "Category" as shown in the above table. For details, please check the explanatory materials regarding the part numbering system of each of our products.

3. Each product series is assigned a "Quality Grade" from 1 to 4 in order of higher quality. Please do not incorporate a product into any equipment with a higher Quality Grade than the Quality Grade of such product without the prior written consent of TAIYO YUDEN.

4. The applications covered by this product series are limited to mobile devices (smartphone, tablet PC, smartwatch, handheld game console, etc.) among general electronic equipment for consumer. The design, specifications and operating environment, etc. differ from those of the product series for "General Electronic Equipment" (Category: S), so please check the individual product specification sheets for details. The product series for "General Electronic Equipment" (Category: S) can also be used for mobile devices.

▶ This catalog contains the typical specification only due to the limitation of space. When you consider the purchase of our products, please check our product specification sheets. For details of each product (characteristics graph, reliability information, precautions for use, and so on), see our website (<http://www.ty-top.com/>).

2. Equipment Requiring Inquiry

Please be sure to contact TAIYO YUDEN for further information before using the products listed in this catalog for the following equipment (excluding intended equipment as specified in this catalog or the individual product specification sheets) which may cause loss of human life, bodily injury, serious property damage and/or serious public impact due to a failure or defect of the products and/or malfunction attributed thereto.

- (1) Transportation equipment (automotive powertrain control system, train control system, and ship control system, etc.)
- (2) Traffic signal equipment
- (3) Disaster prevention equipment, crime prevention equipment
- (4) Medical devices classified as GHTF Class C (Japan Class III)
- (5) Highly public information network equipment, data-processing equipment (telephone exchange, and base station, etc.)
- (6) Any other equipment requiring high levels of quality and/or reliability equal to the equipment listed above

3. Equipment Prohibited for Use

Please do not incorporate our products into the following equipment requiring extremely high levels of safety and/or reliability.

- (1) Aerospace equipment (artificial satellite, rocket, etc.)
- (2) Aviation equipment *1
- (3) Medical devices classified as GHTF Class D (Japan Class IV), implantable medical devices *2
- (4) Power generation control equipment (nuclear power, hydroelectric power, thermal power plant control system, etc.)
- (5) Undersea equipment (submarine repeating equipment, etc.)
- (6) Military equipment
- (7) Any other equipment requiring extremely high levels of safety and/or reliability equal to the equipment listed above

*Notes: 1. There is a possibility that our products can be used only for aviation equipment that does not directly affect the safe operation of aircraft (e.g., in-flight entertainment, cabin light, electric seat, cooking equipment) if such use meets requirements specified separately by TAIYO YUDEN. Please be sure to contact TAIYO YUDEN for further information before using our products for such aviation equipment.

2. Implantable medical devices contain not only internal unit which is implanted in a body, but also external unit which is connected to the internal unit.

4. Limitation of Liability

Please note that unless you obtain prior written consent of TAIYO YUDEN, TAIYO YUDEN shall not be in any way responsible for any damages incurred by you or third parties arising from use of the products listed in this catalog for any equipment that is not intended for use by TAIYO YUDEN, or any equipment requiring inquiry to TAIYO YUDEN or prohibited for use by TAIYO YUDEN as described above.

■ Safety Design

When using our products for high safety and/or reliability-required equipment or circuits, please fully perform safety and/or reliability evaluation. In addition, please install (i) systems equipped with a protection circuit and a protection device and/or (ii) systems equipped with a redundant circuit or other system to prevent an unsafe status in the event of a single fault for a failsafe design to ensure safety.

■ Intellectual Property Rights

Information contained in this catalog is intended to convey examples of typical performances and/or applications of our products and is not intended to make any warranty with respect to the intellectual property rights or any other related rights of TAIYO YUDEN or any third parties nor grant any license under such rights.

■ Limited Warranty

Please note that the scope of warranty for our products is limited to the delivered our products themselves conforming to the product specifications specified in the individual product specification sheets, and TAIYO YUDEN shall not be in any way responsible for any damages resulting from a failure or defect in our products. Notwithstanding the foregoing, if there is a written agreement (e.g., supply and purchase agreement, quality assurance agreement) signed by TAIYO YUDEN and your company, TAIYO YUDEN will warrant our products in accordance with such agreement, provided, however, that our products shall be used for general-purpose and standard use in the equipment specified in this catalog or the individual product specification sheets.

■ TAIYO YUDEN's Official Sales Channel

The contents of this catalog are applicable to our products which are purchased from our sales offices or authorized distributors (hereinafter "TAIYO YUDEN's official sales channel"). Please note that the contents of this catalog are not applicable to our products purchased from any seller other than TAIYO YUDEN's official sales channel.

■ Caution for Export

Some of our products listed in this catalog may require specific procedures for export according to "U.S. Export Administration Regulations", "Foreign Exchange and Foreign Trade Control Law" of Japan, and other applicable regulations. Should you have any questions on this matter, please contact our sales staff.

▶ This catalog contains the typical specification only due to the limitation of space. When you consider the purchase of our products, please check our product specification sheets. For details of each product (characteristics graph, reliability information, precautions for use, and so on), see our website (<http://www.ty-top.com/>).

Medical Application Guide

According to the medical devices classified as GHTF Classes A to C (Japan Classes I to III), we have the corresponding product series (the 2nd code from the left side of the part number is “M” or “L”) intended for use in the medical devices. Therefore, when using our products for the medical devices, please be sure to check the classification based on the GHTF Rules and use the corresponding product series.

On the other hand, we don't have the product series intended for use in (i) all medical devices classified as GHTF Class D (Japan Class IV) and (ii) implantable medical devices (bone-anchored hearing aid, artificial retina system, and external unit which is connected to internal unit which is implanted in a body, etc.). Therefore, please do not incorporate our products into these medical devices. Should you have any questions on this matter, please contact us.

Risk Level		Low  High			
Japan	Classification according to the PMD Act of Japan (based on the GHTF Rules)	Class I General Medical Devices (GHTF Class A)	Class II Controlled Medical Devices (GHTF Class B)	Class III Specially-controlled Medical Devices (GHTF Class C)	Class IV Specially-controlled Medical Devices (GHTF Class D)
		Medical devices with extremely low risk to the human body in case of problems [Ex.] • In Vitro Diagnostic Devices • Nebulizer • Blood Gas Analyzer • Plethysmographs • Breathing Sensor • AC-powered Operating Table • Surgical Light • Cholesterol Analysis Device • Blood Type Analysis Device, etc.	Medical devices with relatively low risk to the human body in case of problems [Ex.] • Electronic Thermometer • Electronic Blood Pressure Gauge • Electronic Endoscope • Hearing Aid • Electrocardiograph • MRI • Ultrasonic Diagnostic System • Diagnostic Imaging Equipment • X-ray Diagnostic Equipment • Central Monitor • Pulse Oximeter, etc.	Medical devices with relatively high risk to the human body in case of problems [Ex.] • Dialysis Machine • Radiation Therapy Equipment • Infusion Pump • Respirator • Glucose Monitoring System • AED (Automated External Defibrillator) • Skin Laser Scanner • Electric Surgical Unit • Insulin Pump, etc.	Medical devices highly invasive to patients and with life-threatening risk in case of problems [Ex.] • Cardiac Pacemaker • Video Flexible Angioscope • Implantable Infusion Pump • Cardiac Electrosurgical Unit • Inspection Device with Cardiac Catheter • Defibrillator, etc.
U.S.A.	FDA Classification	Class I General Controls	Class II General Controls and Special Controls	Class III General Controls and Premarket Approval	
		Medical devices without the possibility of causing serious injury or harm to the patient or user even if there is a defect or malfunction in such medical devices	Medical devices with the possibility of causing injury or harm to the patient or user if there is a defect or malfunction in such medical devices	Medical devices with the possibility of causing serious injury, disability or death to the patient or user if a defect or malfunction occurs in such medical devices	
Corresponding TAIYO YUDEN Product Series	Product Series for Medical Devices classified as GHTF Classes A or B (Japan Classes I or II) (The 2nd Code from the Left Side of the Part Number: “L”)		Product Series for Medical Devices classified as GHTF Class C (Japan Class III) (The 2nd Code from the Left Side of the Part Number: “M”) (See the Note below.)		N / A

* Note : It is prohibited that our products are used in some medical devices such as implantable medical devices even if such medical devices are classified as GHTF Class C (Japan Class III).

► This catalog contains the typical specification only due to the limitation of space. When you consider the purchase of our products, please check our product specification sheets. For details of each product (characteristics graph, reliability information, precautions for use, and so on), see our website (<http://www.ty-top.com/>).

Multilayer Ceramic Capacitors

for Medical Devices classified as GHTF Class C (Japan Class III)

REFLOW

PART NUMBER

M	M	A	S	T	3	1	L	S	B	5	1	0	6	K	T	N	A	0	1
①		②		③		④		⑤		⑥		⑦		⑧		⑨		⑩	

①Series

Code (1)(2)(3)(4)	
MMAS	Multilayer Ceramic Capacitor (High dielectric type) for Medical Devices classified as GHTF Class C (Japan Class III) Multilayer Ceramic Capacitor (Temperature compensating type) for Medical Devices classified as GHTF Class C (Japan Class III)
MMAR	High frequency/Low loss Medium-High Voltage Multilayer Ceramic Capacitor for Medical Devices classified as GHTF Class C (Japan Class III)
MMJC	Soft Termination Multilayer Ceramic Capacitor for Medical Devices classified as GHTF Class C (Japan Class III)
MMRL	LW Reversal Decoupling Low ESL Capacitor (LWDC™) for Medical Devices classified as GHTF Class C (Japan Class III)

(1) Product Group

Code	
M	Multilayer Ceramic Capacitor

(2) Category

Code	Recommended equipment	Quality Grade
M	Medical Devices classified as GHTF Class C (Japan Class III)	2

(3) Type

Code	
A	2 terminals
J	Soft Termination
R	LW reversal

(4) Features, Characteristics

Code	
S	Standard/General
R	High frequency/Low loss
C	Internal code (Soft Termination)
L	Low ESL

②Rated voltage

Code	Rated voltage [VDC]
A	4
J	6.3
L	10
E	16
T	25
G	35
U	50
H	100
Q	250
S	630

④Thickness

Code	Thickness [mm]
3	0.3
5	0.5
7	0.7
8	0.8
9	0.85
Q	1.15
G	1.25
L	1.6
N	1.9 (0.088 max ※)
M	2.5

Note : ※LW reverse type (MMRL)

③Dimension (L × W)

Code	L × W [mm]	JIS(mm)	EIA(inch)
06	0.6 × 0.3	0603	0201
10	1.0 × 0.5	1005	0402
	0.52 × 1.0 ※	0510	0204
16	1.6 × 0.8	1608	0603
	0.8 × 1.6 ※	0816	0306
21	2.0 × 1.25	2012	0805
	1.25 × 2.0 ※	1220	0508
31	3.2 × 1.6	3216	1206
32	3.2 × 2.5	3225	1210
45	4.5 × 3.2	4532	1812

Note : ※LW reverse type (MMRL)

⑤Dimension tolerance

Code	Dimension code	L[mm]	W[mm]	T[mm]	Thickness code
A	10	1.0±0.10	0.5±0.10	0.5±0.10	5
	16	1.6+0.15/-0.05	0.8+0.15/-0.05	0.8+0.15/-0.05	8
	21	2.0+0.15/-0.05	1.25+0.15/-0.05	1.25+0.15/-0.05	G
	31	3.2±0.20	1.6±0.20	1.15±0.20	Q
	32	3.2±0.30	2.5±0.30	1.6±0.20	L
B	10	1.0+0.15/-0.05	0.5+0.15/-0.05	0.5+0.15/-0.05	5
	16	1.6+0.20/-0	0.8+0.20/-0	0.8+0.20/-0	8
	21	2.0+0.20/-0	1.25+0.20/-0	1.25+0.20/-0	G
	31	3.2±0.30	1.6±0.30	1.6±0.30	L
	32	3.2±0.30	2.5±0.30	2.5±0.30	M
C	10	1.0+0.20/-0	0.5+0.20/-0	0.5+0.20/-0	5
	16	1.6+0.25/-0	0.8+0.25/-0	0.8+0.25/-0	8
	21	2.0+0.25/-0	1.25+0.25/-0	1.25+0.25/-0	G
D	21	2.0+0.30/-0	1.25+0.30/-0	1.25+0.30/-0	G
H	31	3.2±0.15	1.6±0.15	1.15±0.10	Q
J	21	2.0+0.15/-0.05	1.25+0.15/-0.05	0.85±0.10	9
L	21	2.0+0.20/-0	1.25+0.20/-0	0.85±0.10	9
	32	3.2±0.50	2.5±0.30	2.5±0.30	M
N	21	2.0±0.15	1.25±0.15	0.85±0.15	9
S	06	0.6±0.03	0.3±0.03	0.3±0.03	3
	10	1.0±0.05	0.5±0.05	0.5±0.05	5
		0.52±0.05 ※	1.0±0.05	0.3±0.05	3
	16	1.6±0.10	0.8±0.10	0.7±0.10	7
		0.8±0.10 ※	1.6±0.10	0.8±0.10	8
				0.5±0.05	5
	21	2.0±0.10	1.25±0.10	0.85±0.10	9
				1.25±0.10	G
		1.25±0.15 ※	2.0±0.15	0.85±0.10	9
	31	3.2±0.15	1.6±0.15	1.6±0.20	L
	32	3.2±0.30	2.5±0.20	1.9±0.20	N
			2.5±0.20	M	
			2.5±0.20	M	
45	4.5±0.40	3.2±0.30	2.5±0.20	M	

Note :※LW reverse type (MMRL)

⑥ Temperature characteristics code

■ High dielectric type

Code	Applicable standard		Temperature range [°C]	Ref. Temp. [°C]	Capacitance change	Capacitance tolerance	Tolerance code
B5	EIA	X5R	-55 ~ + 85	25	± 15%	± 10%	K
						± 20%	M
C6	EIA	X6S	-55 ~ + 105	25	± 22%	± 10%	K
						± 20%	M
B7	EIA	X7R	-55 ~ + 125	25	± 15%	± 10%	K
						± 20%	M
C7	EIA	X7S	-55 ~ + 125	25	± 22%	± 10%	K
						± 20%	M
D7	EIA	X7T	-55 ~ + 125	25	+ 22% / - 33%	± 10%	K
						± 20%	M

■ Temperature compensating type

Code	Applicable standard		Temperature range [°C]	Ref. Temp. [°C]	Capacitance change	Capacitance tolerance	Tolerance code
CG	JIS	CG	-55 ~ + 125	20	0 ± 30ppm/°C	± 0.05pF	A
						± 0.1pF	B
	± 0.25pF	C					
	EIA	C0G		25		± 0.5pF	D
						± 2%	G
± 5%			J				
CH	JIS	CH	-55 ~ + 125	20	0 ± 60ppm/°C	± 0.25pF	C
						± 0.5pF	D
	EIA	COH		25		± 5%	J
CJ	JIS	CJ	-55 ~ + 125	20	0 ± 120ppm/°C	± 0.25pF	C
	EIA	C0J					
CK	JIS	CK	-55 ~ + 125	20	0 ± 250ppm/°C	± 0.25pF	C
	EIA	C0K		25			

⑦ Nominal capacitance

Code (example)	Nominal capacitance
0R5	0.5pF
010	1pF
100	10pF
101	100pF
102	1,000pF
103	0.01μF
104	0.1μF
105	1μF
106	10μF
107	100μF

Note : R=Decimal point

⑧ Capacitance tolerance

Code	Capacitance tolerance
A	± 0.05pF
B	± 0.1pF
C	± 0.25pF
D	± 0.5pF
G	± 2%
J	± 5%
K	± 10%
M	± 20%

⑨ Packaging

Code	Packaging
F	φ178mm Taping (2mm pitch)
R	φ178mm Embossed Taping (4mm pitch)
T	φ178mm Taping (4mm pitch)
P	φ178mm Taping (4mm pitch, 1000 pcs/reel) 3225 type (Thickness code M)

⑩ Internal code

STANDARD EXTERNAL DIMENSIONS

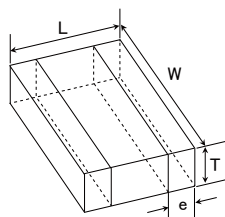
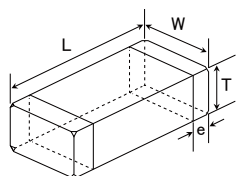

※LW reverse type

Type	JIS (mm)	EIA (inch)	Dimension [mm] (inch)				
			L	W	T	*1	e
MMAS□06	0603	0201	0.6±0.03 (0.024±0.001)	0.3±0.03 (0.012±0.001)	0.3±0.03 (0.012±0.001)	3	0.15±0.05 (0.006±0.002)
MMAR□10 MMAS□10	1005	0402	1.0±0.05 (0.039±0.002)	0.5±0.05 (0.020±0.002)	0.5±0.05 (0.020±0.002)	5	0.25±0.10 (0.010±0.004)
MMRL□10 ※	0510	0204	0.52±0.05 (0.020±0.002)	1.0±0.05 (0.039±0.002)	0.3±0.05 (0.012±0.002)	3	0.18±0.08 (0.007±0.003)
MMAS□16 MMAR□16	1608	0603	1.6±0.10 (0.063±0.004)	0.8±0.10 (0.031±0.004)	0.7±0.10 (0.028±0.004)	7	0.35±0.25 (0.014±0.010)
					0.8±0.10 (0.031±0.004)	8	
MMJC□16	1608	0603	1.6±0.10 (0.063±0.004)	0.8±0.10 (0.031±0.004)	0.8±0.10 (0.031±0.004)	8	0.35+0.3/-0.25 (0.014+0.012/-0.010)
MMRL□16 ※	0816	0306	0.8±0.10 (0.031±0.004)	1.6±0.10 (0.063±0.004)	0.5±0.05 (0.020±0.002)	5	0.25±0.15 (0.010±0.006)
MMAS□21 MMAR□21	2012	0805	2.0±0.10 (0.079±0.004)	1.25±0.10 (0.049±0.004)	0.85±0.10 (0.033±0.004)	9	0.5±0.25 (0.020±0.010)
					1.25±0.10 (0.049±0.004)	G	
MMJC□21	2012	0805	2.0±0.10 (0.079±0.004)	1.25±0.10 (0.049±0.004)	0.85±0.10 (0.033±0.004)	9	0.5+0.35/-0.25 (0.020+0.014/-0.010)
					1.25±0.10 (0.049±0.004)	G	
MMRL□21 ※	1220	0508	1.25±0.15 (0.049±0.006)	2.0±0.15 (0.079±0.006)	0.85±0.10 (0.033±0.004)	9	0.3±0.2 (0.012±0.008)
MMAS□31	3216	1206	3.2±0.15 (0.126±0.006)	1.6±0.15 (0.063±0.006)	1.15±0.10 (0.045±0.004)	Q	0.5+0.35/-0.25 (0.020+0.014/-0.010)
					1.6±0.20 (0.063±0.008)	L	
MMJC□31	3216	1206	3.2±0.15 (0.126±0.006)	1.6±0.15 (0.063±0.006)	1.15±0.10 (0.045±0.004)	Q	0.6+0.4/-0.3 (0.024+0.016/-0.012)
					1.6±0.20 (0.063±0.008)	L	
MMAS□32	3225	1210	3.2±0.30 (0.126±0.012)	2.5±0.20 (0.098±0.008)	1.9±0.20 (0.075±0.008)	N	0.6±0.3 (0.024±0.012)
					2.5±0.20 (0.098±0.008)	M	
MMJC□32	3225	1210	3.2±0.30 (0.126±0.012)	2.5±0.20 (0.098±0.008)	1.9±0.20 (0.075±0.008)	N	0.6+0.4/-0.3 (0.024+0.016/-0.012)
					2.5±0.20 (0.098±0.008)	M	
MMAS□45	4532	1812	4.5±0.40 (0.177±0.016)	3.2±0.30 (0.126±0.012)	2.5±0.20 (0.098±0.008)	M	0.9±0.6 (0.035±0.024)

Note :※LW reverse type (MMRL), *1.Thickness code

■ STANDARD QUANTITY

Type			Thickness		Standard quantity [pcs]	
Code	JIS(mm)	EIA(inch)	[mm]	Code	Paper tape	Embossed tape
06	0603	0201	0.3	3	15000	—
10	1005	0402	0.5	5	10000	—
	0510 ※	0204 ※	0.3	3		
16	1608	0603	0.7	7	4000	—
			0.8	8		
	0816 ※	0306 ※	0.8	8	3000 (Soft Termination)	3000 (Soft Termination)
			0.5	5	—	4000
21	2012	0805	0.85	9	4000	—
			1.25	G	—	3000
			1.25	G	—	2000 (Soft Termination)
	1220 ※	0508 ※	0.85	9	4000	—
31	3216	1206	1.15	Q	—	3000
			1.6	L	—	2000
32	3225	1210	1.9	N	—	2000
			2.5	M	—	500(T), 1000(P)
45	4532	1812	2.5	M	—	500

Note : ※.LW Reverse type (MMRL)

PART NUMBER

- All the Multilayer Ceramic Capacitors of the catalog lineup are RoHS compliant.
- Capacitance tolerance code is applied to □ of part number.
- All the Multilayer Ceramic Capacitors in the catalog lineup are applicable for reflow-soldering.

Notes)

- The exchange of individual specifications is necessary depending on your application and/or circuit condition. Please contact TAIYO YUDEN's official sales channel.
- The products are for Medical Devices classified as GHTF Class C (Japan Class III). Please consult with TAIYO YUDEN's official sales channel for the details of the product specifications, etc., and please review and approve the product specifications before ordering.
- *1: For standard case size, please kindly refer to Dimension, Thickness, Dimension tolerance, and STANDARD EXTERNAL DIMENSIONS.

Multilayer Ceramic Capacitors (High dielectric type) for Medical Devices classified as GHTF Class C (Japan Class III)

● 0603TYPE

【Temperature Characteristic B7 : X7R (−55~+125°C), D7 : X7T (−55~+125°C)】 0.3mm Thickness

New part number	Old part number (for reference)	Rated voltage [V]	Temperature characteristics	Capacitance [F]	Capacitance tolerance [%]	tan δ [%]	HTLT		Thickness*1 [mm]	Note
							Rated voltage x %			
MMAST063SB7101□FCA01	TMK063 B7101□PHFE	25	X7R	100 p	±10, ±20	3.5	200	0.3±0.03		
MMAST063SB7151□FCA01	TMK063 B7151□PHFE		X7R	150 p	±10, ±20	3.5	200	0.3±0.03		
MMAST063SB7221□FCA01	TMK063 B7221□PHFE		X7R	220 p	±10, ±20	3.5	200	0.3±0.03		
MMAST063SB7331□FCA01	TMK063 B7331□PHFE		X7R	330 p	±10, ±20	3.5	200	0.3±0.03		
MMAST063SB7471□FCA01	TMK063 B7471□PHFE		X7R	470 p	±10, ±20	3.5	200	0.3±0.03		
MMAST063SB7681□FCA01	TMK063 B7681□PHFE		X7R	680 p	±10, ±20	5	200	0.3±0.03		
MMAST063SB7102□FCA01	TMK063 B7102□PHFE		X7R	1000 p	±10, ±20	5	200	0.3±0.03		
MMAST063SB7152□FCA01	TMK063 B7152□PHFE		X7R	1500 p	±10, ±20	5	200	0.3±0.03		
MMAST063SB7222□FCA01	TMK063 B7222□PHFE		X7R	2200 p	±10, ±20	5	200	0.3±0.03		
MMAST063SB7332□FCA01	TMK063 B7332□PHFE		X7R	3300 p	±10, ±20	5	200	0.3±0.03		
MMASE063SB7101□FCA01	EMK063 B7101□PHFE		X7R	100 p	±10, ±20	3.5	200	0.3±0.03		
MMASE063SB7151□FCA01	EMK063 B7151□PHFE		X7R	150 p	±10, ±20	3.5	200	0.3±0.03		
MMASE063SB7221□FCA01	EMK063 B7221□PHFE		X7R	220 p	±10, ±20	3.5	200	0.3±0.03		
MMASE063SB7331□FCA01	EMK063 B7331□PHFE		X7R	330 p	±10, ±20	3.5	200	0.3±0.03		
MMASE063SB7471□FCA01	EMK063 B7471□PHFE		X7R	470 p	±10, ±20	3.5	200	0.3±0.03		
MMASE063SB7681□FCA01	EMK063 B7681□PHFE		X7R	680 p	±10, ±20	5	200	0.3±0.03		
MMASE063SB7102□FCA01	EMK063 B7102□PHFE	X7R	1000 p	±10, ±20	5	200	0.3±0.03			
MMASE063SB7152□FCA01	EMK063 B7152□PHFE	X7R	1500 p	±10, ±20	5	200	0.3±0.03			
MMASE063SB7222□FCA01	EMK063 B7222□PHFE	X7R	2200 p	±10, ±20	5	200	0.3±0.03			
MMASE063SB7332□FCA01	EMK063 B7332□PHFE	X7R	3300 p	±10, ±20	5	200	0.3±0.03			
MMASL063SB7101□FCA01	LMK063 B7101□PHFE	10	X7R	100 p	±10, ±20	3.5	200	0.3±0.03		
MMASL063SB7151□FCA01	LMK063 B7151□PHFE		X7R	150 p	±10, ±20	3.5	200	0.3±0.03		
MMASL063SB7221□FCA01	LMK063 B7221□PHFE		X7R	220 p	±10, ±20	3.5	200	0.3±0.03		
MMASL063SB7331□FCA01	LMK063 B7331□PHFE		X7R	330 p	±10, ±20	3.5	200	0.3±0.03		
MMASL063SB7471□FCA01	LMK063 B7471□PHFE		X7R	470 p	±10, ±20	3.5	200	0.3±0.03		
MMASL063SB7681□FCA01	LMK063 B7681□PHFE		X7R	680 p	±10, ±20	5	200	0.3±0.03		
MMASL063SB7102□FCA01	LMK063 B7102□PHFE		X7R	1000 p	±10, ±20	5	200	0.3±0.03		
MMASL063SB7152□FCA01	LMK063 B7152□PHFE		X7R	1500 p	±10, ±20	5	200	0.3±0.03		
MMASL063SB7222□FCA01	LMK063 B7222□PHFE		X7R	2200 p	±10, ±20	5	200	0.3±0.03		
MMASL063SB7332□FCA01	LMK063 B7332□PHFE		X7R	3300 p	±10, ±20	5	200	0.3±0.03		
MMASL063SB7472□FCA01	LMK063 B7472□PHFE		X7R	4700 p	±10, ±20	5	200	0.3±0.03		
MMASL063SB7682□FCA01	LMK063 B7682□PHFE		X7R	6800 p	±10, ±20	5	200	0.3±0.03		
MMASL063SB7103□FCA01	LMK063 B7103□PHFE		X7R	0.01 μ	±10, ±20	5	200	0.3±0.03		
MMASJ063SD7223□FCA01	JMK063 D7223□PHFE		6.3	X7T	0.022 μ	±10, ±20	7.5	200	0.3±0.03	
MMASJ063SD7333□FCA01	JMK063 D7333□PHFE			X7T	0.033 μ	±10, ±20	7.5	200	0.3±0.03	
MMASJ063SD7473□FCA01	JMK063 D7473□PHFE			X7T	0.047 μ	±10, ±20	7.5	200	0.3±0.03	
MMASJ063SD7104□FCA01	JMK063 D7104□PHFE	X7T		0.1 μ	±10, ±20	10	200	0.3±0.03		

▶ This catalog contains the typical specification only due to the limitation of space. When you consider the purchase of our products, please check our specification.
For details of each product (characteristics graph, reliability information, precautions for use, and so on), see our Web site (<http://www.ty-top.com/>).

PART NUMBER

1005TYPE

【Temperature Characteristic B5 (BJ) : X5R (−55~+85°C)】 0.5mm Thickness

New part number	Old part number (for reference)	Rated voltage [V]	Temperature characteristics	Capacitance [F]	Capacitance tolerance [%]	tan δ [%]	HTLT		Thickness*1 [mm]	Note
							Rated voltage x %			
MMASU105SB5471□FNA01	UMK105 BJ471□VHF	50	X5R	470 p	±10, ±20	2.5	200	0.5±0.05		
MMASU105SB5102□FNA01	UMK105 BJ102□VHF		X5R	1000 p	±10, ±20	2.5	200	0.5±0.05		
MMASU105SB5152□FNA01	UMK105 BJ152□VHF		X5R	1500 p	±10, ±20	2.5	200	0.5±0.05		
MMASU105SB5222□FNA01	UMK105 BJ222□VHF		X5R	2200 p	±10, ±20	2.5	200	0.5±0.05		
MMASU105SB5332□FNA01	UMK105 BJ332□VHF		X5R	3300 p	±10, ±20	2.5	200	0.5±0.05		
MMASU105SB5472□FNA01	UMK105 BJ472□VHF		X5R	4700 p	±10, ±20	2.5	200	0.5±0.05		
MMASU105SB5682□FNA01	UMK105 BJ682□VHF		X5R	6800 p	±10, ±20	2.5	150	0.5±0.05		
MMASU105SB5103□FNA01	UMK105 BJ103□VHF		X5R	0.01 μ	±10, ±20	3.5	200	0.5±0.05		
MMASU105SB5223□FNA01	UMK105 BJ223□VHF		X5R	0.022 μ	±10, ±20	5	200	0.5±0.05		
MMASU105SB5473□FNA01	UMK105 BJ473□VHF		X5R	0.047 μ	±10, ±20	5	200	0.5±0.05		
MMASU105SB5104□FNA01	UMK105 BJ104□VHF		X5R	0.1 μ	±10, ±20	10	150	0.5±0.05		
MMAST105SB5472□FNA01	TMK105 BJ472□VHF		25	X5R	4700 p	±10, ±20	2.5	200	0.5±0.05	
MMAST105SB5682□FNA01	TMK105 BJ682□VHF	X5R		6800 p	±10, ±20	2.5	200	0.5±0.05		
MMAST105SB5103□FNA01	TMK105 BJ103□VHF	X5R		0.01 μ	±10, ±20	3.5	200	0.5±0.05		
MMAST105SB5153□FNA01	TMK105 BJ153□VHF	X5R		0.015 μ	±10, ±20	3.5	200	0.5±0.05		
MMAST105SB5223□FNA01	TMK105 BJ223□VHF	X5R		0.022 μ	±10, ±20	3.5	200	0.5±0.05		
MMAST105SB5333□FNA01	TMK105 BJ333□VHF	X5R		0.033 μ	±10, ±20	3.5	150	0.5±0.05		
MMAST105SB5473□FNA01	TMK105 BJ473□VHF	X5R		0.047 μ	±10, ±20	3.5	150	0.5±0.05		
MMAST105SB5104□FNA01	TMK105 BJ104□VHF	X5R		0.1 μ	±10, ±20	5	150	0.5±0.05		
MMAST105SB5224□FNA01	TMK105 BJ224□VHF	X5R		0.22 μ	±10, ±20	10	150	0.5±0.05		
MMAST105AB5474□FNA01	TMK105ABJ474□VHF	X5R		0.47 μ	±10, ±20	10	150	0.5±0.10		
MMASE105SB5104□FNA01	EMK105 BJ104□VHF	16		X5R	0.1 μ	±10, ±20	5	150	0.5±0.05	
MMASE105SB5224□FNA01	EMK105 BJ224□VHF			X5R	0.22 μ	±10, ±20	10	150	0.5±0.05	
MMASE105AB5474□FNA01	EMK105ABJ474□VHF		X5R	0.47 μ	±10, ±20	10	150	0.5±0.10		
MMASE105SB5105□FNA01	EMK105 BJ105□VHF		X5R	1 μ	±10, ±20	10	150	0.5±0.05		
MMASL105SB5224□FNA01	LMK105 BJ224□VHF	10	X5R	0.22 μ	±10, ±20	5	150	0.5±0.05		
MMASL105AB5474□FNA01	LMK105ABJ474□VHF		X5R	0.47 μ	±10, ±20	10	150	0.5±0.10		
MMASL105SB5105□FNA01	LMK105 BJ105□VHF		X5R	1 μ	±10, ±20	10	150	0.5±0.05		
MMASL105AB5225□FNA01	LMK105ABJ225□VHF		X5R	2.2 μ	±10, ±20	10	150	0.5±0.10		
MMASJ105SB5474□FNA01	JMK105 BJ474□VHF	6.3	X5R	0.47 μ	±10, ±20	10	150	0.5±0.05		
MMASJ105SB5105□FNA01	JMK105 BJ105□VHF		X5R	1 μ	±10, ±20	10	150	0.5±0.05		
MMASJ105SB5225□FNA01	JMK105 BJ225□VHF		X5R	2.2 μ	±10, ±20	10	150	0.5±0.05		
MMASJ105BB5475MFNA01	JMK105BBJ475MVHF		X5R	4.7 μ	±20	10	150	0.5+0.15/-0.05		
MMASA105SB5225□FNA01	AMK105 BJ225□VHF	4	X5R	2.2 μ	±10, ±20	10	150	0.5±0.05		
MMASA105BB5475MFNA01	AMK105BBJ475MVHF		X5R	4.7 μ	±20	10	150	0.5+0.15/-0.05		

【Temperature Characteristic C6 : X6S (−55~+105°C)】 0.5mm Thickness

New part number	Old part number (for reference)	Rated voltage [V]	Temperature characteristics	Capacitance [F]	Capacitance tolerance [%]	tan δ [%]	HTLT		Thickness*1 [mm]	Note
							Rated voltage x %			
MMASE105AC6474□FNA01	EMK105AC6474□VHF	16	X6S	0.47 μ	±10, ±20	10	150	0.5±0.10		
MMASL105SC6105□FNA01	LMK105 C6105□VHF	10	X6S	1 μ	±10, ±20	10	150	0.5±0.05		
MMASJ105SC6105□FNA01	JMK105 C6105□VHF	6.3	X6S	1 μ	±10, ±20	10	150	0.5±0.05		

▶ This catalog contains the typical specification only due to the limitation of space. When you consider the purchase of our products, please check our specification.
For details of each product (characteristics graph, reliability information, precautions for use, and so on), see our Web site (<http://www.ty-top.com/>).

■ PART NUMBER

【Temperature Characteristic B7 : X7R(−55~+125°C), D7 : X7T(−55~+125°C)】 0.5mm Thickness

New part number	Old part number (for reference)	Rated voltage [V]	Temperature characteristics	Capacitance [F]	Capacitance tolerance [%]	tan δ [%]	HTLT	Thickness*1 [mm]	Note		
							Rated voltage x %				
MMASU105SB7221□FNA01	UMK105 B7221□VHF	50	X7R	220 p	±10, ±20	2.5	200	0.5±0.05			
MMASU105SB7331□FNA01	UMK105 B7331□VHF		X7R	330 p	±10, ±20	2.5	200	0.5±0.05			
MMASU105SB7471□FNA01	UMK105 B7471□VHF		X7R	470 p	±10, ±20	2.5	200	0.5±0.05			
MMASU105SB7681□FNA01	UMK105 B7681□VHF		X7R	680 p	±10, ±20	2.5	200	0.5±0.05			
MMASU105SB7102□FNA01	UMK105 B7102□VHF		X7R	1000 p	±10, ±20	2.5	200	0.5±0.05			
MMASU105SB7152□FNA01	UMK105 B7152□VHF		X7R	1500 p	±10, ±20	2.5	200	0.5±0.05			
MMASU105SB7222□FNA01	UMK105 B7222□VHF		X7R	2200 p	±10, ±20	2.5	200	0.5±0.05			
MMASU105SB7332□FNA01	UMK105 B7332□VHF		X7R	3300 p	±10, ±20	2.5	200	0.5±0.05			
MMASU105SB7472□FNA01	UMK105 B7472□VHF		X7R	4700 p	±10, ±20	2.5	150	0.5±0.05			
MMASU105SB7682□FNA01	UMK105 B7682□VHF		X7R	6800 p	±10, ±20	2.5	150	0.5±0.05			
MMASU105SB7103□FNA01	UMK105 B7103□VHF		X7R	0.01 μ	±10, ±20	3.5	150	0.5±0.05			
MMASU105SB7153□FCA01	UMK105 B7153□VHF		X7R	0.015 μ	±10, ±20	3.5	200	0.5±0.05			
MMASU105SB7223□FNA01	UMK105 B7223□VHF		X7R	0.022 μ	±10, ±20	10	200	0.5±0.05			
MMASU105SB7333□FCA01	UMK105 B7333□VHFE		X7R	0.033 μ	±10, ±20	3.5	150	0.5±0.05			
MMASU105SB7473□FNA01	UMK105 B7473□VHF		X7R	0.047 μ	±10, ±20	10	200	0.5±0.05			
MMASU105AB7683□FCA01	UMK105AB7683KVHFE		X7R	0.068 μ	±10, ±20	5	150	0.5±0.1			
MMASU105SB7104□FNA01	UMK105 B7104□VHF		X7R	0.1 μ	±10, ±20	10	150	0.5±0.05			
MMAST105SB7472□FNA01	TMK105 B7472□VHF		25	X7R	4700 p	±10, ±20	2.5	200	0.5±0.05		
MMAST105SB7682□FNA01	TMK105 B7682□VHF			X7R	6800 p	±10, ±20	2.5	200	0.5±0.05		
MMAST105SB7103□FNA01	TMK105 B7103□VHF			X7R	0.01 μ	±10, ±20	3.5	200	0.5±0.05		
MMAST105SB7153□FNA01	TMK105 B7153□VHF			X7R	0.015 μ	±10, ±20	3.5	150	0.5±0.05		
MMAST105SB7223□FNA01	TMK105 B7223□VHF			X7R	0.022 μ	±10, ±20	3.5	150	0.5±0.05		
MMAST105SB7333□FNA01	TMK105 B7333□VHF			X7R	0.033 μ	±10, ±20	3.5	150	0.5±0.05		
MMAST105SB7473□FNA01	TMK105 B7473□VHF			X7R	0.047 μ	±10, ±20	3.5	150	0.5±0.05		
MMAST105AB7683□FCA01	TMK105AB7683KVHFE			X7R	0.068 μ	±10, ±20	5	200	0.5±0.1		
MMAST105SB7104□FNA01	TMK105 B7104□VHF	X7R		0.1 μ	±10, ±20	10	150	0.5±0.05			
MMASE105SB7103□FNA01	EMK105 B7103□VHF	16		X7R	0.01 μ	±10, ±20	3.5	200	0.5±0.05		
MMASE105SB7153□FNA01	EMK105 B7153□VHF			X7R	0.015 μ	±10, ±20	3.5	150	0.5±0.05		
MMASE105SB7223□FNA01	EMK105 B7223□VHF			X7R	0.022 μ	±10, ±20	3.5	150	0.5±0.05		
MMASE105SB7333□FNA01	EMK105 B7333□VHF			X7R	0.033 μ	±10, ±20	3.5	150	0.5±0.05		
MMASE105SB7473□FNA01	EMK105 B7473□VHF			X7R	0.047 μ	±10, ±20	3.5	150	0.5±0.05		
MMASE105SB7104□FNA01	EMK105 B7104□VHF			X7R	0.1 μ	±10, ±20	5	150	0.5±0.05		
MMASE105SB7224□FNA01	EMK105 B7224□VHF			X7R	0.22 μ	±10, ±20	10	150	0.5±0.05		
MMASL105SB7473□FNA01	LMK105 B7473□VHF			10	X7R	0.047 μ	±10, ±20	3.5	150	0.5±0.05	
MMASL105SB7104□FNA01	LMK105 B7104□VHF				X7R	0.1 μ	±10, ±20	5	150	0.5±0.05	
MMASL105SB7224□FNA01	LMK105 B7224□VHF				X7R	0.22 μ	±10, ±20	10	150	0.5±0.05	
MMASL105AD7474□FCA01	LMK105AD7474□VHFE	X7T			0.47 μ	±10, ±20	10	150	0.5±0.10		
MMASL105CD7105□FCA01	LMK105CD7105□VHFE	X7T			1 μ	±10, ±20	10	150	0.5+0.20/-0		
MMASJ105SB7104□FNA01	JMK105 B7104□VHF	6.3		X7R	0.1 μ	±10, ±20	5	150	0.5±0.05		
MMASJ105SB7224□FNA01	JMK105 B7224□VHF			X7R	0.22 μ	±10, ±20	10	150	0.5±0.05		
MMASJ105SB7474□FNA01	JMK105 B7474□VHF			X7R	0.47 μ	±10, ±20	10	150	0.5±0.05		
MMASJ105CD7105□FNA01	JMK105CD7105□VHF			X7T	1 μ	±10, ±20	10	150	0.5+0.20/-0		
MMASA105SB7474□FNA01	AMK105 B7474□VHF		4	X7R	0.47 μ	±10, ±20	10	150	0.5±0.05		

● 1608TYPE

【Temperature Characteristic B5(BJ) : X5R(−55~+85°C)】 0.8mm Thickness

New part number	Old part number (for reference)	Rated voltage [V]	Temperature characteristics	Capacitance [F]	Capacitance tolerance [%]	tan δ [%]	HTLT	Thickness*1 [mm]	Note
							Rated voltage x %		
MMASU168SB5224□TNA01	UMK107 BJ224□AHT	50	X5R	0.22 μ	±10, ±20	10	150	0.8±0.10	
MMASU168SB5474□TNA01	UMK107 BJ474□AHT		X5R	0.47 μ	±10, ±20	10	150	0.8±0.10	
MMASU168AB5105□TNA01	UMK107ABJ105□AHT		X5R	1 μ	±10, ±20	10	150	0.8+0.15/-0.05	
MMASG168SB5224□TNA01	GMK107 BJ224□AHT		X5R	0.22 μ	±10, ±20	10	150	0.8±0.10	
MMASG168AB5474□TNA01	GMK107ABJ474□AHT		X5R	0.47 μ	±10, ±20	10	150	0.8+0.15/-0.05	
MMASG168SB5105□TNA01	GMK107 BJ105□AHT	35	X5R	1 μ	±10, ±20	10	150	0.8±0.10	
MMAST168SB5224□TNA01	TMK107 BJ224□AHT		X5R	0.22 μ	±10, ±20	5	150	0.8±0.10	
MMAST168SB5474□TNA01	TMK107 BJ474□AHT		X5R	0.47 μ	±10, ±20	3.5	150	0.8±0.10	
MMAST168SB5105□TNA01	TMK107 BJ105□AHT		X5R	1 μ	±10, ±20	10	150	0.8±0.10	
MMAST168BB5225□TNA01	TMK107BBJ225□AHT		X5R	2.2 μ	±10, ±20	10	150	0.8+0.20/-0	
MMASE168SB5105□TNA01	EMK107 BJ105□AHT	25	X5R	1 μ	±10, ±20	5	150	0.8±0.10	
MMASE168AB5225□TNA01	EMK107ABJ225□AHT		X5R	2.2 μ	±10, ±20	10	150	0.8+0.15/-0.05	
MMASE168BB5475□TNA01	EMK107BBJ475□AHT		X5R	4.7 μ	±10, ±20	10	150	0.8+0.20/-0	
MMASL168SB5225□TNA01	LMK107 BJ225□AHT		X5R	2.2 μ	±10, ±20	10	150	0.8±0.10	
MMASL168SB5475□TNA01	LMK107 BJ475□AHT		X5R	4.7 μ	±10, ±20	10	150	0.8±0.10	
MMASL168BB5106MTNA01	LMK107BBJ106MAHT	10	X5R	10 μ	±20	10	150	0.8+0.20/-0	
MMASJ168SB5475□TNA01	JMK107 BJ475□AHT		X5R	4.7 μ	±10, ±20	10	150	0.8±0.10	
MMASJ168AB5106□TNA01	JMK107ABJ106□AHT		X5R	10 μ	±10, ±20	10	150	0.8+0.15/-0.05	
MMASA168AB5106□TNA01	AMK107ABJ106□AHT		X5R	10 μ	±10, ±20	10	150	0.8+0.15/-0.05	
MMASA168BB5226MTNA01	AMK107BBJ226MAHT		X5R	22 μ	±20	10	150	0.8+0.20/-0	

【Temperature Characteristic C6 : X6S(−55~+105°C)】 0.8mm Thickness

New part number	Old part number (for reference)	Rated voltage [V]	Temperature characteristics	Capacitance [F]	Capacitance tolerance [%]	tan δ [%]	HTLT	Thickness*1 [mm]	Note
							Rated voltage x %		
MMASL168SC6225□TNA01	LMK107 C6225□AHT	10	X6S	2.2 μ	±10, ±20	10	150	0.8±0.10	
MMASJ168AC6475□TNA01	JMK107AC6475□AHT	6.3	X6S	4.7 μ	±10, ±20	10	150	0.8+0.15/-0.05	
MMASJ168BC6106MTNA01	JMK107BC6106MAHT		X6S	10 μ	±20	10	150	0.8+0.20/-0	

▶ This catalog contains the typical specification only due to the limitation of space. When you consider the purchase of our products, please check our specification.
For details of each product (characteristics graph, reliability information, precautions for use, and so on), see our Web site (<http://www.ty-top.com/>).

PART NUMBER

【Temperature Characteristic B7 : X7R(-55~+125°C), C7 : X7S(-55~+125°C), D7 : X7T(-55~+125°C)】 0.8mm Thickness

New part number	Old part number (for reference)	Rated voltage [V]	Temperature characteristics	Capacitance [F]	Capacitance tolerance [%]	tan δ [%]	HTLT	Thickness*1 [mm]	Note
							Rated voltage x %		
MMASU168AC7154□TCA01	UMK107AC7154□AHT	50	X7S	0.15 μ	±10, ±20	3.5	150	0.8±0.15/-0.05	
MMASU168SC7224□TCA01	UMK107 C7224□AHT		X7S	0.22 μ	±10, ±20	3.5	150	0.8±0.10	
MMASU168SB7474□TCA01	UMK107 B7474□AHT		X7R	0.47 μ	±10, ±20	10	150	0.8±0.10	
MMASG168SB7224□TNA01	GMK107 B7224□AHT		X7R	0.22 μ	±10, ±20	10	150	0.8±0.10	
MMASG168SB7474□TNA01	GMK107 B7474□AHT	35	X7R	0.47 μ	±10, ±20	10	150	0.8±0.10	
MMASG168AB7105□TNA01	GMK107AB7105□AHT		X7R	1 μ	±10, ±20	10	150	0.8±0.15/-0.05	
MMAST168SB7224□TNA01	TMK107 B7224□AHT	25	X7R	0.22 μ	±10, ±20	10	150	0.8±0.10	
MMAST168SB7474□TNA01	TMK107 B7474□AHT		X7R	0.47 μ	±10, ±20	10	150	0.8±0.10	
MMAST168AB7105□TNA01	TMK107AB7105□AHT	16	X7R	1 μ	±10, ±20	10	150	0.8±0.15/-0.05	
MMASE168SB7224□TNA01	EMK107 B7224□AHT		X7R	0.22 μ	±10, ±20	5	150	0.8±0.10	
MMASE168SB7474□TNA01	EMK107 B7474□AHT	10	X7R	0.47 μ	±10, ±20	10	150	0.8±0.10	
MMASE168SB7105□TNA01	EMK107 B7105□AHT		X7R	1 μ	±10, ±20	10	150	0.8±0.10	
MMASL168SB7474□TNA01	LMK107 B7474□AHT	6.3	X7R	0.47 μ	±10, ±20	3.5	150	0.8±0.10	
MMASL168SB7105□TNA01	LMK107 B7105□AHT		X7R	1 μ	±10, ±20	10	150	0.8±0.10	
MMASL168BD7225□TNA01	LMK107BD7225□AHT		X7T	2.2 μ	±10, ±20	10	200	0.8±0.20/-0	
MMASJ168SB7105□TNA01	JMK107 B7105□AHT	6.3	X7R	1 μ	±10, ±20	10	150	0.8±0.10	
MMASJ168SB7225□TNB25	JMK107 B7225□AHT		X7R	2.2 μ	±10, ±20	10	150	0.8±0.10	

2012TYPE

【Temperature Characteristic B5(BJ) : X5R(-55~+85°C)】 1.25mm Thickness

New part number	Old part number (for reference)	Rated voltage [V]	Temperature characteristics	Capacitance [F]	Capacitance tolerance [%]	tan δ [%]	HTLT	Thickness*1 [mm]	Note
							Rated voltage x %		
MMASU21GSB5474□TNA01	UMK212 BJ474□GHT	50	X5R	0.47 μ	±10, ±20	3.5	150	1.25±0.10	
MMASU21GSB5105□TNA01	UMK212 BJ105□GHT		X5R	1 μ	±10, ±20	5	150	1.25±0.10	
MMASG21GSB5105□TNA01	GMK212 BJ105□GHT	35	X5R	1 μ	±10, ±20	5	150	1.25±0.10	
MMASG21GSB5225□TNA01	GMK212BBJ225□GHT		X5R	2.2 μ	±10, ±20	10	150	1.25±0.20/-0	
MMAST21GSB5225□TNA01	TMK212 BJ225□GHT	25	X5R	2.2 μ	±10, ±20	5	150	1.25±0.10	
MMAST21GSB5475□TNA01	TMK212BBJ475□GHT		X5R	4.7 μ	±10, ±20	10	150	1.25±0.20/-0	
MMAST21GSB5106□TNA01	TMK212BBJ106□GHT	16	X5R	10 μ	±10, ±20	10	150	1.25±0.20/-0	
MMASE21GSB5225□TNA01	EMK212 BJ225□GHT		X5R	2.2 μ	±10, ±20	5	150	1.25±0.10	
MMASE21GAB5475□TNA01	EMK212ABJ475□GHT	10	X5R	4.7 μ	±10, ±20	10	150	1.25±0.15/-0.05	
MMASE21GAB5106□TNA01	EMK212BBJ106□GHT		X5R	10 μ	±10, ±20	10	150	1.25±0.20/-0	
MMASL21GAB5475□TNA01	LMK212ABJ475□GHT	6.3	X5R	4.7 μ	±10, ±20	10	150	1.25±0.15/-0.05	
MMASL21GAB5106□TNA01	LMK212ABJ106□GHT		X5R	10 μ	±10, ±20	10	150	1.25±0.15/-0.05	
MMASJ21GAB5106□TNA01	JMK212ABJ106□GHT	4	X5R	10 μ	±10, ±20	10	150	1.25±0.15/-0.05	
MMASJ21GSB5226MTNA01	UMK212BBJ226MGHT		X5R	22 μ	±20	10	150	1.25±0.20/-0	
MMASA21GSB5476MTNA01	AMK212BBJ476MGHT		X5R	47 μ	±20	10	150	1.25±0.20/-0	

【Temperature Characteristic B5(BJ) : X5R(-55~+85°C)】 0.85mm Thickness

New part number	Old part number (for reference)	Rated voltage [V]	Temperature characteristics	Capacitance [F]	Capacitance tolerance [%]	tan δ [%]	HTLT	Thickness*1 [mm]	Note
							Rated voltage x %		
MMASE219JB5225□TNA01	EMK212ABJ225□DHT	16	X5R	2.2 μ	±10, ±20	5	150	0.85±0.10	
MMASE219LB5475□TNA01	EMK212BBJ475□DHT		X5R	4.7 μ	±10, ±20	10	150	0.85±0.10	

【Temperature Characteristic C6 : X6S(-55~+105°C)】 1.25mm Thickness

New part number	Old part number (for reference)	Rated voltage [V]	Temperature characteristics	Capacitance [F]	Capacitance tolerance [%]	tan δ [%]	HTLT	Thickness*1 [mm]	Note
							Rated voltage x %		
MMASL21GBC6106□TNA01	LMK212BC6106□GHT	10	X6S	10 μ	±10, ±20	10	150	1.25±0.20/-0	
MMASA21GBC6226MTNA01	AMK212BC6226MGHT	4	X6S	22 μ	±20	10	150	1.25±0.20/-0	

【Temperature Characteristic B7 : X7R(-55~+125°C), C7 : X7S(-55~+125°C)】 1.25mm Thickness

New part number	Old part number (for reference)	Rated voltage [V]	Temperature characteristics	Capacitance [F]	Capacitance tolerance [%]	tan δ [%]	HTLT	Thickness*1 [mm]	Note
							Rated voltage x %		
MMASU21GSB7473□TNA01	UMK212 B7473□GHT	50	X7R	0.047 μ	±10, ±20	3.5	200	1.25±0.10	
MMASU21GSB7683□TNA01	UMK212 B7683□GHT		X7R	0.068 μ	±10, ±20	3.5	200	1.25±0.10	
MMASU21GSB7104□TNA01	UMK212 B7104□GHT		X7R	0.1 μ	±10, ±20	3.5	200	1.25±0.10	
MMASU21GSB7154□TCA01	UMK212BB7154□GHTE		X7R	0.15 μ	±10, ±20	3.5	200	1.25±0.2/-0	
MMASU21GSB7224□TNA01	UMK212 B7224□GHT		X7R	0.22 μ	±10, ±20	3.5	150	1.25±0.10	
MMASU21GBC7334□TCA01	UMK212BC7334□GHTE		X7S	0.33 μ	±10, ±20	3.5	150	1.25±0.2/-0	
MMASU21GSC7474□TCA01	UMK212 C7474□GHTE		X7S	0.47 μ	±10, ±20	3.5	150	1.25±0.10	
MMASU21GCC7684□TCA01	UMK212CC7684□GHTE		X7S	0.68 μ	±10, ±20	3.5	150	1.25±0.25/-0	
MMASU21GSB7105□TNA01	UMK212 B7105□GHT		X7R	1 μ	±10, ±20	10	150	1.25±0.10	
MMASG21GSB7105□TNA01	GMK212 B7105□GHT		35	X7R	1 μ	±10, ±20	10	150	1.25±0.10
MMAST21GSB7474□TNA01	TMK212 B7474□GHT	X7R		0.47 μ	±10, ±20	3.5	150	1.25±0.10	
MMAST21GSB7105□TNB25	TMK212 B7105□GHTR	25	X7R	1 μ	±10, ±20	10	150	1.25±0.10	
MMAST21GSB7225□TNA01	TMK212 B7225□GHT		X7R	2.2 μ	±10, ±20	10	150	1.25±0.10	
MMASE21GSB7105□TNB25	EMK212 B7105□GHTR	16	X7R	1 μ	±10, ±20	10	150	1.25±0.10	
MMASE21GSB7225□TNA01	EMK212 B7225□GHT		X7R	2.2 μ	±10, ±20	10	150	1.25±0.10	
MMASE21GAB7475□TNA01	EMK212AB7475□GHT	10	X7R	4.7 μ	±10, ±20	10	150	1.25±0.15/-0.05	
MMASL21GSB7225□TNA01	LMK212 B7225□GHT		X7R	2.2 μ	±10, ±20	10	150	1.25±0.10	
MMASL21GSB7475□TNA01	LMK212 B7475□GHT	6.3	X7R	4.7 μ	±10, ±20	10	150	1.25±0.10	
MMASL21GSB7106□TNA01	LMK212BB7106□GHT		X7R	10 μ	±10, ±20	10	150	1.25±0.2/-0	
MMASJ21GSB7475□TNA01	JMK212 B7475□GHT	6.3	X7R	4.7 μ	±10, ±20	10	150	1.25±0.10	
MMASJ21GAB7106□TNA01	JMK212AB7106□GHT		X7R	10 μ	±10, ±20	10	150	1.25±0.15/-0.05	

▶ This catalog contains the typical specification only due to the limitation of space. When you consider the purchase of our products, please check our specification.
For details of each product (characteristics graph, reliability information, precautions for use, and so on), see our Web site (<http://www.ty-top.com/>).

PART NUMBER

3216TYPE

【Temperature Characteristic B5(BJ) : X5R(-55~+85°C)】 1.6mm Thickness

New part number	Old part number (for reference)	Rated voltage [V]	Temperature characteristics	Capacitance [F]	Capacitance tolerance [%]	tan δ [%]	HTLT	Thickness*1 [mm]	Note
							Rated voltage x %		
MMASU31LSB5225□TNA01	UMK316 BJ225□LHT	50	X5R	2.2 μ	±10, ±20	10	150	1.6±0.20	
MMASU31LAB5475□TNA01	UMK316ABJ475□LHT		X5R	4.7 μ	±10, ±20	10	150	1.6±0.20	
MMASG31LSB5225□TNA01	GMK316 BJ225□LHT	35	X5R	2.2 μ	±10, ±20	10	150	1.6±0.20	
MMASG31LSB5475□TNA01	GMK316 BJ475□LHT		X5R	4.7 μ	±10, ±20	10	150	1.6±0.20	
MMASG31LBB5106□TNA01	GMK316BBJ106□LHT	25	X5R	10 μ	±10, ±20	10	150	1.6±0.30	
MMAST31LSB5475□TNA01	TMK316 BJ475□LHT		X5R	4.7 μ	±10, ±20	5	150	1.6±0.20	
MMAST31LSB5106□TNA01	TMK316 BJ106□LHT	16	X5R	10 μ	±10, ±20	5	150	1.6±0.20	
MMASE31LSB5475□TNA01	EMK316 BJ475□LHT		X5R	4.7 μ	±10, ±20	5	150	1.6±0.20	
MMASE31LSB5106□TNA01	EMK316 BJ106□LHT	10	X5R	10 μ	±10, ±20	5	150	1.6±0.20	
MMASE31LBB5226MTNA01	EMK316BBJ226MLHT		X5R	22 μ	±20	10	150	1.6±0.30	
MMASL31LAB5226□TNA01	LMK316ABJ226□LHT	6.3	X5R	22 μ	±10, ±20	10	150	1.6±0.20	
MMASJ31LAB5476MTNA01	JMK316ABJ476MLHT		X5R	47 μ	±20	10	150	1.6±0.20	
MMASJ31LBB5107MTNA01	JMK316BBJ107MLHT	4	X5R	100 μ	±20	10	150	1.6±0.20	
MMASA31LAB5107MTNA01	JMK316ABJ107MLHT		X5R	100 μ	±20	10	150	1.6±0.20	

【Temperature Characteristic B7 : X7R(-55~+125°C), C7 : X7S(-55~+125°C)】 1.6mm Thickness

New part number	Old part number (for reference)	Rated voltage [V]	Temperature characteristics	Capacitance [F]	Capacitance tolerance [%]	tan δ [%]	HTLT	Thickness*1 [mm]	Note
							Rated voltage x %		
MMASU31LSB7105□TNA01	UMK316 B7105□LHT	50	X7R	1 μ	±10, ±20	3.5	200	1.6±0.20	
MMASU31LBC7155□TCA01	UMK316BC7155□LHTE		X7S	1.5 μ	±10, ±20	3.5	150	1.6±0.30	
MMASU31LSB7225□TNA01	UMK316 B7225□LHT	35	X7R	2.2 μ	±10, ±20	10	150	1.6±0.20	
MMASG31LAC7475□TCA01	UMK316AC7475□LHTE		X7S	4.7 μ	±10, ±20	2.5	150	1.6±0.20	
MMASG31LSB7225□TNA01	GMK316 B7225□LHT	25	X7R	2.2 μ	±10, ±20	10	150	1.6±0.20	
MMASG31LAB7475□TNA01	GMK316AB7475□LHT		X7R	4.7 μ	±10, ±20	10	150	1.6±0.20	
MMAST31LAB7475□TNA01	TMK316AB7475□LHT	16	X7R	4.7 μ	±10, ±20	10	150	1.6±0.20	
MMAST31LAB7106□TNA01	TMK316AB7106□LHT		X7R	10 μ	±10, ±20	10	150	1.6±0.20	
MMASE31LAB7475□TNA01	EMK316AB7475□LHT	10	X7R	4.7 μ	±10, ±20	10	150	1.6±0.20	
MMASE31LAB7106□TNA01	EMK316AB7106□LHT		X7R	10 μ	±10, ±20	10	150	1.6±0.20	
MMASL31LAB7106□TNA01	LMK316AB7106□LHT	6.3	X7R	10 μ	±10, ±20	10	150	1.6±0.20	
MMASJ31LAB7226□TNA01	JMK316AB7226□LHT		X7R	22 μ	±10, ±20	10	150	1.6±0.20	
MMASA31LAB7226□TNA01	AMK316AB7226□LHT	4	X7R	22 μ	±10, ±20	10	150	1.6±0.20	
MMASA31LAC7476MTNA01	AMK316AC7476MLHT		X7S	47 μ	±20	10	150	1.6±0.20	

3225TYPE

【Temperature Characteristic B5(BJ) : X5R(-55~+85°C)】 2.5mm Thickness

New part number	Old part number (for reference)	Rated voltage [V]	Temperature characteristics	Capacitance [F]	Capacitance tolerance [%]	tan δ [%]	HTLT	Thickness*1 [mm]	Note
							Rated voltage x %		
MMASU32MSB5106□PNA01	UMK325 BJ106□MHP	50	X5R	10 μ	±10, ±20	5	150	2.5±0.20	
MMASE32MAB5476□PNDT1	EMK325ABJ476□MHHP	16	X5R	47 μ	±10, ±20	10	150	2.5±0.30	
MMASL32MSB5476□PNA01	LMK325 BJ476□MHP	10	X5R	47 μ	±10, ±20	10	150	2.5±0.20	
MMASL32MAB5107MPNA01	JMK325AB5107MPNA01		X5R	100 μ	±20	10	150	2.5±0.30	
MMASJ32MAB5107MPNA01	JMK325AB5107MPNA01	6.3	X5R	100 μ	±20	10	150	2.5±0.30	
MMASA32MAB5107MPNA01	JMK325AB5107MPNA01	4	X5R	100 μ	±20	10	150	2.5±0.30	

【Temperature Characteristic C6 : X6S(-55~+105°C)】 2.5mm Thickness

New part number	Old part number (for reference)	Rated voltage [V]	Temperature characteristics	Capacitance [F]	Capacitance tolerance [%]	tan δ [%]	HTLT	Thickness*1 [mm]	Note
							Rated voltage x %		
MMASJ32MAC6107MPNA01		6.3	X6S	100 μ	±20	10	150	2.5±0.30	

【Temperature Characteristic B7 : X7R(-55~+125°C)】 2.5mm Thickness

New part number	Old part number (for reference)	Rated voltage [V]	Temperature characteristics	Capacitance [F]	Capacitance tolerance [%]	tan δ [%]	HTLT	Thickness*1 [mm]	Note
							Rated voltage x %		
MMASU32MSB7475□PNA01	UMK325 B7475□MHP	50	X7R	4.7 μ	±10, ±20	5	150	2.5±0.20	
MMASU32MAB7106□PNA01	UMK325AB7106□MHHP		X7R	10 μ	±10, ±20	10	150	2.5±0.30	
MMASG32MAB7106□PNA01	GMK325AB7106□JMHP	35	X7R	10 μ	±10, ±20	10	150	2.5±0.30	
MMAST32MAB7106□PNB25	TMK325AB7106□JMHP	25	X7R	10 μ	±10, ±20	10	150	2.5±0.30	
MMAST32MSB7226□PNA01	TMK325 B7226□MHP		X7R	22 μ	±10, ±20	10	150	2.5±0.20	
MMASE32MSB7226□PNA01	EMK325 B7226□MHP	16	X7R	22 μ	±10, ±20	10	150	2.5±0.20	
MMASL32MSB7226□PNA01	LMK325 B7226□MHP	10	X7R	22 μ	±10, ±20	10	150	2.5±0.20	
MMASJ32MSB7476□PNB25	JMK325 B7476□JMHP	6.3	X7R	47 μ	±10, ±20	10	150	2.5±0.20	

■ PART NUMBER

Multilayer Ceramic Capacitors (Temperature compensating type) for Medical Devices classified as GHTF Class C (Japan Class III)

● 0603TYPE

【Temperature Characteristic CΔ : CΔ/C0Δ (-55~+125°C)】 0.3mm Thickness

New part number	Old part number (for reference)	Rated voltage [V]	Temperature characteristics		Capacitance [F]	Capacitance tolerance	Q [at 1MHz] (Min)	HTLT	Thickness*1 [mm]	Note	
								Rated voltage x %			
MMASU063SCK0R5CFNA01	UMK063 CK0R5CTHF	50	CK	C0K	0.5 p	±0.25pF	410	200	0.3±0.03		
MMASU063SCK010CFNA01	UMK063 CK010CTHF		CK	C0K	1 p	±0.25pF	420	200	0.3±0.03		
MMASU063SCK1R5CFNA01	UMK063 CK1R5CTHF		CK	C0K	1.5 p	±0.25pF	430	200	0.3±0.03		
MMASU063SCK020CFNA01	UMK063 CK020CTHF		CK	C0K	2 p	±0.25pF	440	200	0.3±0.03		
MMASU063SCJ030CFNA01	UMK063 CJ030CTHF		CJ	C0J	3 p	±0.25pF	460	200	0.3±0.03		
MMASU063SCH040CFNA01	UMK063 CH040CTHF		CH	C0H	4 p	±0.25pF	480	200	0.3±0.03		
MMASU063SCH050CFNA01	UMK063 CH050CTHF		CH	C0H	5 p	±0.25pF	500	200	0.3±0.03		
MMASU063SCH060DFNA01	UMK063 CH060DTHF		CH	C0H	6 p	±0.5pF	520	200	0.3±0.03		
MMASU063SCH070DFNA01	UMK063 CH070DTHF		CH	C0H	7 p	±0.5pF	540	200	0.3±0.03		
MMASU063SCH080DFNA01	UMK063 CH080DTHF		CH	C0H	8 p	±0.5pF	560	200	0.3±0.03		
MMASU063SCH090DFNA01	UMK063 CH090DTHF		CH	C0H	9 p	±0.5pF	580	200	0.3±0.03		
MMASU063SCH100DFNA01	UMK063 CH100DTHF		CH	C0H	10 p	±0.5pF	600	200	0.3±0.03		
MMASU063SCH120JFNA01	UMK063 CH120JTHF		CH	C0H	12 p	±5%	640	200	0.3±0.03		
MMASU063SCH150JFNA01	UMK063 CH150JTHF		CH	C0H	15 p	±5%	700	200	0.3±0.03		
MMASU063SCH180JFNA01	UMK063 CH180JTHF		CH	C0H	18 p	±5%	760	200	0.3±0.03		
MMASU063SCH220JFNA01	UMK063 CH220JTHF		CH	C0H	22 p	±5%	840	200	0.3±0.03		
MMASU063SCH270JFNA01	UMK063 CH270JTHF		CH	C0H	27 p	±5%	940	200	0.3±0.03		
MMASU063SCH330JFNA01	UMK063 CH330JTHF		CH	C0H	33 p	±5%	1000	200	0.3±0.03		
MMASU063SCH390JFNA01	UMK063 CH390JTHF		CH	C0H	39 p	±5%	1000	200	0.3±0.03		
MMASU063SCH470JFNA01	UMK063 CH470JTHF		CH	C0H	47 p	±5%	1000	200	0.3±0.03		
MMASU063SCH560JFNA01	UMK063 CH560JTHF		CH	C0H	56 p	±5%	1000	200	0.3±0.03		
MMASU063SCH680JFNA01	UMK063 CH680JTHF		CH	C0H	68 p	±5%	1000	200	0.3±0.03		
MMASU063SCH820JFNA01	UMK063 CH820JTHF		CH	C0H	82 p	±5%	1000	200	0.3±0.03		
MMASU063SCH101JFNA01	UMK063 CH101JTHF		CH	C0H	100 p	±5%	1000	200	0.3±0.03		
MMASU063SCH121JFNA01	UMK063 CH121JTHF		CH	C0H	120 p	±5%	1000	200	0.3±0.03		
MMASU063SCH151JFNA01	UMK063 CH151JTHF		CH	C0H	150 p	±5%	1000	200	0.3±0.03		
MMASU063SCH181JFNA01	UMK063 CH181JTHF		CH	C0H	180 p	±5%	1000	200	0.3±0.03		
MMASU063SCH221JFNA01	UMK063 CH221JTHF		CH	C0H	220 p	±5%	1000	200	0.3±0.03		
MMAST063SCH121JFNA01	TMK063 CH121JTHF		25	CH	C0H	120 p	±5%	1000	200	0.3±0.03	
MMAST063SCH151JFNA01	TMK063 CH151JTHF			CH	C0H	150 p	±5%	1000	200	0.3±0.03	
MMAST063SCH181JFNA01	TMK063 CH181JTHF			CH	C0H	180 p	±5%	1000	200	0.3±0.03	
MMAST063SCH221JFNA01	TMK063 CH221JTHF			CH	C0H	220 p	±5%	1000	200	0.3±0.03	
MMASU063SCG0R5CFNA01	UMK063 CG0R5CTHF		50	CG	C0G	0.5 p	±0.25pF	410	200	0.3±0.03	
MMASU063SCG010CFNA01	UMK063 CG010CTHF			CG	C0G	1 p	±0.25pF	420	200	0.3±0.03	
MMASU063SCG1R5CFNA01	UMK063 CG1R5CTHF			CG	C0G	1.5 p	±0.25pF	430	200	0.3±0.03	
MMASU063SCG020CFNA01	UMK063 CG020CTHF			CG	C0G	2 p	±0.25pF	440	200	0.3±0.03	
MMASU063SCG030CFNA01	UMK063 CG030CTHF	CG		C0G	3 p	±0.25pF	460	200	0.3±0.03		
MMASU063SCG040CFNA01	UMK063 CG040CTHF	CG		C0G	4 p	±0.25pF	480	200	0.3±0.03		
MMASU063SCG050CFNA01	UMK063 CG050CTHF	CG		C0G	5 p	±0.25pF	500	200	0.3±0.03		
MMASU063SCG060DFNA01	UMK063 CG060DTHF	CG		C0G	6 p	±0.5pF	520	200	0.3±0.03		
MMASU063SCG070DFNA01	UMK063 CG070DTHF	CG		C0G	7 p	±0.5pF	540	200	0.3±0.03		
MMASU063SCG080DFNA01	UMK063 CG080DTHF	CG		C0G	8 p	±0.5pF	560	200	0.3±0.03		
MMASU063SCG090DFNA01	UMK063 CG090DTHF	CG		C0G	9 p	±0.5pF	580	200	0.3±0.03		
MMASU063SCG100DFNA01	UMK063 CG100DTHF	CG		C0G	10 p	±0.5pF	600	200	0.3±0.03		
MMASU063SCG120JFNA01	UMK063 CG120JTHF	CG		C0G	12 p	±5%	640	200	0.3±0.03		
MMASU063SCG150JFNA01	UMK063 CG150JTHF	CG		C0G	15 p	±5%	700	200	0.3±0.03		
MMASU063SCG180JFNA01	UMK063 CG180JTHF	CG		C0G	18 p	±5%	760	200	0.3±0.03		
MMASU063SCG220JFNA01	UMK063 CG220JTHF	CG		C0G	22 p	±5%	840	200	0.3±0.03		
MMASU063SCG270JFNA01	UMK063 CG270JTHF	CG		C0G	27 p	±5%	940	200	0.3±0.03		
MMASU063SCG330JFNA01	UMK063 CG330JTHF	CG		C0G	33 p	±5%	1000	200	0.3±0.03		
MMASU063SCG390JFNA01	UMK063 CG390JTHF	CG		C0G	39 p	±5%	1000	200	0.3±0.03		
MMASU063SCG470JFNA01	UMK063 CG470JTHF	CG		C0G	47 p	±5%	1000	200	0.3±0.03		
MMASU063SCG560JFNA01	UMK063 CG560JTHF	CG		C0G	56 p	±5%	1000	200	0.3±0.03		
MMASU063SCG680JFNA01	UMK063 CG680JTHF	CG		C0G	68 p	±5%	1000	200	0.3±0.03		
MMASU063SCG820JFNA01	UMK063 CG820JTHF	CG		C0G	82 p	±5%	1000	200	0.3±0.03		
MMASU063SCG101JFNA01	UMK063 CG101JTHF	CG		C0G	100 p	±5%	1000	200	0.3±0.03		
MMASU063SCG121JFNA01	UMK063 CG121JTHF	CG		C0G	120 p	±5%	1000	200	0.3±0.03		
MMASU063SCG151JFNA01	UMK063 CG151JTHF	CG		C0G	150 p	±5%	1000	200	0.3±0.03		
MMASU063SCG181JFNA01	UMK063 CG181JTHF	CG		C0G	180 p	±5%	1000	200	0.3±0.03		
MMASU063SCG221JFNA01	UMK063 CG221JTHF	CG		C0G	220 p	±5%	1000	200	0.3±0.03		
MMAST063SCG121JFNA01	TMK063 CG121JTHF	25		CG	C0G	120 p	±5%	1000	200	0.3±0.03	
MMAST063SCG151JFNA01	TMK063 CG151JTHF			CG	C0G	150 p	±5%	1000	200	0.3±0.03	
MMAST063SCG181JFNA01	TMK063 CG181JTHF			CG	C0G	180 p	±5%	1000	200	0.3±0.03	
MMAST063SCG221JFNA01	TMK063 CG221JTHF			CG	C0G	220 p	±5%	1000	200	0.3±0.03	

▶ This catalog contains the typical specification only due to the limitation of space. When you consider the purchase of our products, please check our specification.
For details of each product (characteristics graph, reliability information, precautions for use, and so on), see our Web site (<http://www.ty-top.com/>).

■ PART NUMBER

● 1005TYPE

【Temperature Characteristic $C\Delta : C\Delta/C0\Delta (-55\sim+125^{\circ}C)$ 】 0.5mm Thickness

New part number	Old part number (for reference)	Rated voltage [V]	Temperature characteristics		Capacitance [F]	Capacitance tolerance	Q [at 1MHz] (Min)	HTLT	Thickness*1 [mm]	Note
								Rated voltage x %		
MMASU105SCK0R5CFNA01	UMK105 CK0R5CVHF	50	CK	C0K	0.5 p	±0.25pF	410	200	0.5±0.05	
MMASU105SCK010CFNA01	UMK105 CK010CVHF		CK	C0K	1 p	±0.25pF	420	200	0.5±0.05	
MMASU105SCK1R5CFNA01	UMK105 CK1R5CVHF		CK	C0K	1.5 p	±0.25pF	430	200	0.5±0.05	
MMASU105SCK020CFNA01	UMK105 CK020CVHF		CK	C0K	2 p	±0.25pF	440	200	0.5±0.05	
MMASU105SCJ030CFNA01	UMK105 CJ030CVHF		CJ	C0J	3 p	±0.25pF	460	200	0.5±0.05	
MMASU105SCH040CFNA01	UMK105 CH040CVHF		CH	C0H	4 p	±0.25pF	480	200	0.5±0.05	
MMASU105SCH050CFNA01	UMK105 CH050CVHF		CH	C0H	5 p	±0.25pF	500	200	0.5±0.05	
MMASU105SCH060DFNA01	UMK105 CH060DVHF		CH	C0H	6 p	±0.5pF	520	200	0.5±0.05	
MMASU105SCH070DFNA01	UMK105 CH070DVHF		CH	C0H	7 p	±0.5pF	540	200	0.5±0.05	
MMASU105SCH080DFNA01	UMK105 CH080DVHF		CH	C0H	8 p	±0.5pF	560	200	0.5±0.05	
MMASU105SCH090DFNA01	UMK105 CH090DVHF		CH	C0H	9 p	±0.5pF	580	200	0.5±0.05	
MMASU105SCH100DFNA01	UMK105 CH100DVHF		CH	C0H	10 p	±0.5pF	600	200	0.5±0.05	
MMASU105SCH120JFNA01	UMK105 CH120JVHF		CH	C0H	12 p	±5%	640	200	0.5±0.05	
MMASU105SCH150JFNA01	UMK105 CH150JVHF		CH	C0H	15 p	±5%	700	200	0.5±0.05	
MMASU105SCH180JFNA01	UMK105 CH180JVHF		CH	C0H	18 p	±5%	760	200	0.5±0.05	
MMASU105SCH220JFNA01	UMK105 CH220JVHF		CH	C0H	22 p	±5%	840	200	0.5±0.05	
MMASU105SCH270JFNA01	UMK105 CH270JVHF		CH	C0H	27 p	±5%	940	200	0.5±0.05	
MMASU105SCH330JFNA01	UMK105 CH330JVHF		CH	C0H	33 p	±5%	1000	200	0.5±0.05	
MMASU105SCH390JFNA01	UMK105 CH390JVHF		CH	C0H	39 p	±5%	1000	200	0.5±0.05	
MMASU105SCH470JFNA01	UMK105 CH470JVHF		CH	C0H	47 p	±5%	1000	200	0.5±0.05	
MMASU105SCH560JFNA01	UMK105 CH560JVHF		CH	C0H	56 p	±5%	1000	200	0.5±0.05	
MMASU105SCH680JFNA01	UMK105 CH680JVHF		CH	C0H	68 p	±5%	1000	200	0.5±0.05	
MMASU105SCH820JFNA01	UMK105 CH820JVHF		CH	C0H	82 p	±5%	1000	200	0.5±0.05	
MMASU105SCH101JFNA01	UMK105 CH101JVHF		CH	C0H	100 p	±5%	1000	200	0.5±0.05	
MMASU105SCH121JFNA01	UMK105 CH121JVHF		CH	C0H	120 p	±5%	1000	200	0.5±0.05	
MMASU105SCH151JFNA01	UMK105 CH151JVHF		CH	C0H	150 p	±5%	1000	200	0.5±0.05	
MMASU105SCH181JFNA01	UMK105 CH181JVHF		CH	C0H	180 p	±5%	1000	200	0.5±0.05	
MMASU105SCH221JFNA01	UMK105 CH221JVHF		CH	C0H	220 p	±5%	1000	200	0.5±0.05	
MMASU105SCH271JFNA01	UMK105 CH271JVHF		CH	C0H	270 p	±5%	1000	200	0.5±0.05	
MMASU105SCH331JFNA01	UMK105 CH331JVHF		CH	C0H	330 p	±5%	1000	200	0.5±0.05	
MMASU105SCH391JFNA01	UMK105 CH391JVHF		CH	C0H	390 p	±5%	1000	200	0.5±0.05	
MMASU105SCH471JFNA01	UMK105 CH471JVHF		CH	C0H	470 p	±5%	1000	200	0.5±0.05	
MMASU105SCH561JFNA01	UMK105 CH561JVHF		CH	C0H	560 p	±5%	1000	200	0.5±0.05	
MMASU105SCH681JFNA01	UMK105 CH681JVHF		CH	C0H	680 p	±5%	1000	200	0.5±0.05	
MMASU105SCH821JFNA01	UMK105 CH821JVHF		CH	C0H	820 p	±5%	1000	200	0.5±0.05	
MMASU105SCH102JFNA01	UMK105 CH102JVHF		CH	C0H	1000 p	±5%	1000	200	0.5±0.05	
MMASU105SCG0R5CFNA01	UMK105 CG0R5CVHF		CG	C0G	0.5 p	±0.25pF	410	200	0.5±0.05	
MMASU105SCG010CFNA01	UMK105 CG010CVHF		CG	C0G	1 p	±0.25pF	420	200	0.5±0.05	
MMASU105SCG1R5CFNA01	UMK105 CG1R5CVHF		CG	C0G	1.5 p	±0.25pF	430	200	0.5±0.05	
MMASU105SCG020CFNA01	UMK105 CG020CVHF		CG	C0G	2 p	±0.25pF	440	200	0.5±0.05	
MMASU105SCG030CFNA01	UMK105 CG030CVHF	CG	C0G	3 p	±0.25pF	460	200	0.5±0.05		
MMASU105SCG040CFNA01	UMK105 CG040CVHF	CG	C0G	4 p	±0.25pF	480	200	0.5±0.05		
MMASU105SCG050CFNA01	UMK105 CG050CVHF	CG	C0G	5 p	±0.25pF	500	200	0.5±0.05		
MMASU105SCG060DFNA01	UMK105 CG060DVHF	CG	C0G	6 p	±0.5pF	520	200	0.5±0.05		
MMASU105SCG070DFNA01	UMK105 CG070DVHF	CG	C0G	7 p	±0.5pF	540	200	0.5±0.05		
MMASU105SCG080DFNA01	UMK105 CG080DVHF	CG	C0G	8 p	±0.5pF	560	200	0.5±0.05		
MMASU105SCG090DFNA01	UMK105 CG090DVHF	CG	C0G	9 p	±0.5pF	580	200	0.5±0.05		
MMASU105SCG100DFNA01	UMK105 CG100DVHF	CG	C0G	10 p	±0.5pF	600	200	0.5±0.05		
MMASU105SCG120JFNA01	UMK105 CG120JVHF	CG	C0G	12 p	±5%	640	200	0.5±0.05		
MMASU105SCG150JFNA01	UMK105 CG150JVHF	CG	C0G	15 p	±5%	700	200	0.5±0.05		
MMASU105SCG180JFNA01	UMK105 CG180JVHF	CG	C0G	18 p	±5%	760	200	0.5±0.05		
MMASU105SCG220JFNA01	UMK105 CG220JVHF	CG	C0G	22 p	±5%	840	200	0.5±0.05		
MMASU105SCG270JFNA01	UMK105 CG270JVHF	CG	C0G	27 p	±5%	940	200	0.5±0.05		
MMASU105SCG330JFNA01	UMK105 CG330JVHF	CG	C0G	33 p	±5%	1000	200	0.5±0.05		
MMASU105SCG390JFNA01	UMK105 CG390JVHF	CG	C0G	39 p	±5%	1000	200	0.5±0.05		
MMASU105SCG470JFNA01	UMK105 CG470JVHF	CG	C0G	47 p	±5%	1000	200	0.5±0.05		
MMASU105SCG560JFNA01	UMK105 CG560JVHF	CG	C0G	56 p	±5%	1000	200	0.5±0.05		
MMASU105SCG680JFNA01	UMK105 CG680JVHF	CG	C0G	68 p	±5%	1000	200	0.5±0.05		
MMASU105SCG820JFNA01	UMK105 CG820JVHF	CG	C0G	82 p	±5%	1000	200	0.5±0.05		
MMASU105SCG101JFNA01	UMK105 CG101JVHF	CG	C0G	100 p	±5%	1000	200	0.5±0.05		
MMASU105SCG121JFNA01	UMK105 CG121JVHF	CG	C0G	120 p	±5%	1000	200	0.5±0.05		
MMASU105SCG151JFNA01	UMK105 CG151JVHF	CG	C0G	150 p	±5%	1000	200	0.5±0.05		
MMASU105SCG181JFNA01	UMK105 CG181JVHF	CG	C0G	180 p	±5%	1000	200	0.5±0.05		
MMASU105SCG221JFNA01	UMK105 CG221JVHF	CG	C0G	220 p	±5%	1000	200	0.5±0.05		
MMASU105SCG271JFNA01	UMK105 CG271JVHF	CG	C0G	270 p	±5%	1000	200	0.5±0.05		
MMASU105SCG331JFNA01	UMK105 CG331JVHF	CG	C0G	330 p	±5%	1000	200	0.5±0.05		
MMASU105SCG391JFNA01	UMK105 CG391JVHF	CG	C0G	390 p	±5%	1000	200	0.5±0.05		
MMASU105SCG471JFNA01	UMK105 CG471JVHF	CG	C0G	470 p	±5%	1000	200	0.5±0.05		
MMASU105SCG561JFNA01	UMK105 CG561JVHF	CG	C0G	560 p	±5%	1000	200	0.5±0.05		
MMASU105SCG681JFNA01	UMK105 CG681JVHF	CG	C0G	680 p	±5%	1000	200	0.5±0.05		
MMASU105SCG821JFNA01	UMK105 CG821JVHF	CG	C0G	820 p	±5%	1000	200	0.5±0.05		
MMASU105SCG102JFNA01	UMK105 CG102JVHF	CG	C0G	1000 p	±5%	1000	200	0.5±0.05		

▶ This catalog contains the typical specification only due to the limitation of space. When you consider the purchase of our products, please check our specification.
For details of each product (characteristics graph, reliability information, precautions for use, and so on), see our Web site (<http://www.ty-top.com/>).

PART NUMBER

Medium-High Voltage Multilayer Ceramic Capacitors for Medical Devices classified as GHTF Class C (Japan Class III)

● 1005TYPE

【Temperature Characteristic B7 : X7R(−55~+125°C), C7 : X7S(−55~+125°C)】 0.5mm Thickness

New part number	Old part number (for reference)	Rated voltage [V]	Temperature characteristics	Capacitance [F]	Capacitance tolerance [%]	tan δ [%]	HTLT		Note
							Rated voltage x %	Thickness*1 [mm]	
MMASH105SB7221□FCA01	HMK105 B7221□VHFE	100	X7R	220 p	±10, ±20	3.5	200	0.5±0.05	
MMASH105SB7331□FCA01	HMK105 B7331□VHFE		X7R	330 p	±10, ±20	3.5	200	0.5±0.05	
MMASH105SB7471□FCA01	HMK105 B7471□VHFE		X7R	470 p	±10, ±20	3.5	200	0.5±0.05	
MMASH105SB7681□FCA01	HMK105 B7681□VHFE		X7R	680 p	±10, ±20	3.5	200	0.5±0.05	
MMASH105SB7102□FCA01	HMK105 B7102□VHFE		X7R	1000 p	±10, ±20	3.5	200	0.5±0.05	
MMASH105SB7152□FCA01	HMK105 B7152□VHFE		X7R	1500 p	±10, ±20	3.5	200	0.5±0.05	
MMASH105SB7222□FCA01	HMK105 B7222□VHFE		X7R	2200 p	±10, ±20	3.5	200	0.5±0.05	
MMASH105SB7332□FCA01	HMK105 B7332□VHFE		X7R	3300 p	±10, ±20	3.5	200	0.5±0.05	
MMASH105SB7472□FCA01	HMK105 B7472□VHFE		X7R	4700 p	±10, ±20	3.5	200	0.5±0.05	
MMASH105SB7682□FCA01	HMK105 B7682□VHFE		X7R	6800 p	±10, ±20	3.5	200	0.5±0.05	
MMASH105SB7103□FCA01	HMK105 B7103□VHFE		X7R	0.01 μ	±10, ±20	3.5	200	0.5±0.05	

● 1608TYPE

【Temperature Characteristic B7 : X7R(−55~+125°C), C7 : X7S(−55~+125°C)】 0.8mm Thickness

New part number	Old part number (for reference)	Rated voltage [V]	Temperature characteristics	Capacitance [F]	Capacitance tolerance [%]	tan δ [%]	HTLT		Note
							Rated voltage x %	Thickness*1 [mm]	
MMASH168SB7102□TNA01	HMK107 B7102□AHT	100	X7R	1000 p	±10, ±20	3.5	200	0.8±0.10	
MMASH168SB7152□TNA01	HMK107 B7152□AHT		X7R	1500 p	±10, ±20	3.5	200	0.8±0.10	
MMASH168SB7222□TNA01	HMK107 B7222□AHT		X7R	2200 p	±10, ±20	3.5	200	0.8±0.10	
MMASH168SB7332□TNA01	HMK107 B7332□AHT		X7R	3300 p	±10, ±20	3.5	200	0.8±0.10	
MMASH168SB7472□TNA01	HMK107 B7472□AHT		X7R	4700 p	±10, ±20	3.5	200	0.8±0.10	
MMASH168SB7682□TNA01	HMK107 B7682□AHT		X7R	6800 p	±10, ±20	3.5	200	0.8±0.10	
MMASH168SB7103□TNA01	HMK107 B7103□AHT		X7R	0.01 μ	±10, ±20	3.5	200	0.8±0.10	
MMASH168SB7153□TNA01	HMK107 B7153□AHT		X7R	0.015 μ	±10, ±20	3.5	200	0.8±0.10	
MMASH168SB7223□TNA01	HMK107 B7223□AHT		X7R	0.022 μ	±10, ±20	3.5	200	0.8±0.10	
MMASH168SB7333□TNA01	HMK107 B7333□AHT		X7R	0.033 μ	±10, ±20	3.5	200	0.8±0.10	
MMASH168SB7473□TNA01	HMK107 B7473□AHT		X7R	0.047 μ	±10, ±20	3.5	200	0.8±0.10	
MMASH168AB7683□TCA01	HMK107AB7683□AHT		X7R	0.068 μ	±10, ±20	3.5	200	0.8±0.15/-0.05	
MMASH168SB7104□TNA01	HMK107 B7104□AHT		X7R	0.1 μ	±10, ±20	3.5	200	0.8±0.10	
MMASH168AC7154□TCA01	HMK107AC7154□AHT		X7S	0.15 μ	±10, ±20	3.5	150	0.8±0.15/-0.05	
MMASH168SC7224□TCA01	HMK107 C7224□AHT		X7S	0.22 μ	±10, ±20	3.5	150	0.8±0.10	

● 2012TYPE

【Temperature Characteristic B7 : X7R(−55~+125°C), C7 : X7S(−55~+125°C)】 1.25mm Thickness

New part number	Old part number (for reference)	Rated voltage [V]	Temperature characteristics	Capacitance [F]	Capacitance tolerance [%]	tan δ [%]	HTLT		Note	
							Rated voltage x %	Thickness*1 [mm]		
MMASH21GSB7333□TNA01	HMK212 B7333□GHT	100	X7R	0.033 μ	±10, ±20	3.5	200	1.25±0.10		
MMASH21GSB7473□TNA01	HMK212 B7473□GHT		X7R	0.047 μ	±10, ±20	3.5	200	1.25±0.10		
MMASH21GSB7683□TNA01	HMK212 B7683□GHT		X7R	0.068 μ	±10, ±20	3.5	200	1.25±0.10		
MMASH21GSB7104□TNA01	HMK212 B7104□GHT		X7R	0.1 μ	±10, ±20	3.5	200	1.25±0.10		
MMASH21GBB7154□TCA01	HMK212BB7154□GHTE		X7R	0.15 μ	±10, ±20	3.5	200	1.25±0.20/-0		
MMASH21GSB7224□TNA01	HMK212 B7224□GHT		X7R	0.22 μ	±10, ±20	3.5	200	1.25±0.10		
MMASH21GBC7334□TCA01	HMK212BC7334□GHTE		X7S	0.33 μ	±10, ±20	3.5	150	1.25±0.20/-0		
MMASH21GSC7474□TCA01	HMK212 C7474□GHTE		X7S	0.47 μ	±10, ±20	3.5	150	1.25±0.10		
MMASH21GCC7684□TCA01	HMK212CC7684□GHTE		X7S	0.68 μ	±10, ±20	3.5	150	1.25±0.25/-0		
MMASH21GBC7105□TCA01	HMK212BC7105□GHTE		X7S	1 μ	±10, ±20	3.5	150	1.25±0.20/-0		
MMASQ21GSB7472□TNA01	QMK212 B7472□GHT		250	X7R	4700 p	±10, ±20	2.5	150	1.25±0.10	
MMASQ21GSB7682□TNA01	QMK212 B7682□GHT			X7R	6800 p	±10, ±20	2.5	150	1.25±0.10	
MMASQ21GSB7103□TNA01	QMK212 B7103□GHT			X7R	0.01 μ	±10, ±20	2.5	150	1.25±0.10	
MMASQ21GSB7153□TNA01	QMK212 B7153□GHT	X7R		0.015 μ	±10, ±20	2.5	150	1.25±0.10		
MMASQ21GSB7223□TNA01	QMK212 B7223□GHT	X7R		0.022 μ	±10, ±20	2.5	150	1.25±0.10		
MMASQ21GAB7473□TCA01	QMK212AB7473□GHTE	X7R		0.047 μ	±10, ±20	2.5	150	1.25±0.15/-0.05		

【Temperature Characteristic B7 : X7R(−55~+125°C)】 0.85mm Thickness

New part number	Old part number (for reference)	Rated voltage [V]	Temperature characteristics	Capacitance [F]	Capacitance tolerance [%]	tan δ [%]	HTLT		Note
							Rated voltage x %	Thickness*1 [mm]	
MMASQ219SB7102□TNA01	QMK212 B7102□DHT	250	X7R	1000 p	±10, ±20	2.5	150	0.85±0.10	
MMASQ219SB7152□TNA01	QMK212 B7152□DHT		X7R	1500 p	±10, ±20	2.5	150	0.85±0.10	
MMASQ219SB7222□TNA01	QMK212 B7222□DHT		X7R	2200 p	±10, ±20	2.5	150	0.85±0.10	
MMASQ219SB7332□TNA01	QMK212 B7332□DHT		X7R	3300 p	±10, ±20	2.5	150	0.85±0.10	

PART NUMBER

3216TYPE

【Temperature Characteristic B7 : X7R (−55~+125°C), C7 : X7S (−55~+125°C)】 1.6mm Thickness

New part number	Old part number (for reference)	Rated voltage [V]	Temperature characteristics	Capacitance [F]	Capacitance tolerance [%]	tan δ [%]	HTLT		Thickness*1 [mm]	Note
							Rated voltage x %			
MMASH31LSB7224□TNA01	HMK316 B7224□LHT	100	X7R	0.22 μ	±10, ±20	3.5	200	1.6±0.20		
MMASH31LSB7334□TNA01	HMK316 B7334□LHT		X7R	0.33 μ	±10, ±20	3.5	200	1.6±0.20		
MMASH31LSB7474□TNA01	HMK316 B7474□LHT		X7R	0.47 μ	±10, ±20	3.5	200	1.6±0.20		
MMASH31LSB7684□TCA01	HMK316 B7684□LHTE		X7R	0.68 μ	±10, ±20	3.5	200	1.6±0.20		
MMASH31LSB7105□TNA01	HMK316 B7105□LHT		X7R	1 μ	±10, ±20	3.5	200	1.6±0.20		
MMASH31LBC7155□TCA01	HMK316BC7155□LHTE		X7S	1.5 μ	±10, ±20	3.5	150	1.6±0.30		
MMASH31LAC7225□TCA01	HMK316AC7225□LHTE	X7S	2.2 μ	±10, ±20	3.5	150	1.6±0.20			
MMASQ31LSB7223□TNA01	QMK316 B7223□LHT	250	X7R	0.022 μ	±10, ±20	2.5	150	1.6±0.20		
MMASQ31LSB7333□TNA01	QMK316 B7333□LHT		X7R	0.033 μ	±10, ±20	2.5	150	1.6±0.20		
MMASQ31LSB7473□TNA01	QMK316 B7473□LHT		X7R	0.047 μ	±10, ±20	2.5	150	1.6±0.20		
MMASQ31LSB7683□TNA01	QMK316 B7683□LHT		X7R	0.068 μ	±10, ±20	2.5	150	1.6±0.20		
MMASQ31LSB7104□TNA01	QMK316 B7104□LHT		X7R	0.1 μ	±10, ±20	2.5	150	1.6±0.20		
MMASS31LSB7153□TNA01	SMK316 B7153□LHT		X7R	0.015 μ	±10, ±20	2.5	120	1.6±0.20		
MMASS31LSB7223□TNA01	SMK316 B7223□LHT	630	X7R	0.022 μ	±10, ±20	2.5	120	1.6±0.20		
MMASS31LAB7333□TNA01	SMK316AB7333□LHT		X7R	0.033 μ	±10, ±20	2.5	120	1.6±0.20		
MMASS31LAB7473□TNA01	SMK316AB7473□LHT		X7R	0.047 μ	±10, ±20	2.5	120	1.6±0.20		

【Temperature Characteristic B7 : X7R (−55~+125°C)】 1.15mm Thickness

New part number	Old part number (for reference)	Rated voltage [V]	Temperature characteristics	Capacitance [F]	Capacitance tolerance [%]	tan δ [%]	HTLT		Thickness*1 [mm]	Note
							Rated voltage x %			
MMASS31QHB7102□TNA01	SMK316 B7102□FHT	630	X7R	1000 p	±10, ±20	2.5	120	1.15±0.10		
MMASS31QHB7152□TNA01	SMK316 B7152□FHT		X7R	1500 p	±10, ±20	2.5	120	1.15±0.10		
MMASS31QHB7222□TNA01	SMK316 B7222□FHT		X7R	2200 p	±10, ±20	2.5	120	1.15±0.10		
MMASS31QHB7332□TNA01	SMK316 B7332□FHT		X7R	3300 p	±10, ±20	2.5	120	1.15±0.10		
MMASS31QHB7472□TNA01	SMK316 B7472□FHT		X7R	4700 p	±10, ±20	2.5	120	1.15±0.10		
MMASS31QHB7682□TNA01	SMK316 B7682□FHT		X7R	6800 p	±10, ±20	2.5	120	1.15±0.10		
MMASS31QHB7103□TNA01	SMK316 B7103□FHT		X7R	0.01 μ	±10, ±20	2.5	120	1.15±0.10		

3225TYPE

【Temperature Characteristic B7 : X7R (−55~+125°C), C7 : X7S (−55~+125°C)】 2.5mm Thickness

New part number	Old part number (for reference)	Rated voltage [V]	Temperature characteristics	Capacitance [F]	Capacitance tolerance [%]	tan δ [%]	HTLT		Thickness*1 [mm]	Note
							Rated voltage x %			
MMASH32MSB7225□PNA01	HMK325 B7225□MHP	100	X7R	2.2 μ	±10, ±20	3.5	200	2.5±0.20		
MMASH32MSC7475□PCA01	HMK325 C7475□MHPE		X7S	4.7 μ	±10, ±20	3.5	150	2.5±0.20		

【Temperature Characteristic B7 : X7R (−55~+125°C)】 1.9mm Thickness

New part number	Old part number (for reference)	Rated voltage [V]	Temperature characteristics	Capacitance [F]	Capacitance tolerance [%]	tan δ [%]	HTLT		Thickness*1 [mm]	Note
							Rated voltage x %			
MMASQ32NSB7473□TNA01	QMK325 B7473□NHT	250	X7R	0.047 μ	±10, ±20	2.5	150	1.9±0.20		
MMASQ32NSB7104□TNA01	QMK325 B7104□NHT		X7R	0.1 μ	±10, ±20	2.5	150	1.9±0.20		
MMASQ32NSB7154□TNA01	QMK325 B7154□NHT		X7R	0.15 μ	±10, ±20	2.5	150	1.9±0.20		
MMASQ32NSB7224□TNA01	QMK325 B7224□NHT		X7R	0.22 μ	±10, ±20	2.5	150	1.9±0.20		
MMASS32NSB7223□TNA01	SMK325 B7223□NHT		630	X7R	0.022 μ	±10, ±20	2.5	120	1.9±0.20	
MMASS32NSB7333□TNA01	SMK325 B7333□NHT			X7R	0.033 μ	±10, ±20	2.5	120	1.9±0.20	
MMASS32NSB7473□TNA01	SMK325 B7473□NHT	X7R		0.047 μ	±10, ±20	2.5	120	1.9±0.20		

4532TYPE

【Temperature Characteristic B7 : X7R (−55~+125°C)】 2.5mm Thickness

New part number	Old part number (for reference)	Rated voltage [V]	Temperature characteristics	Capacitance [F]	Capacitance tolerance [%]	tan δ [%]	HTLT		Thickness*1 [mm]	Note
							Rated voltage x %			
MMASQ45MSB7104□TNA01	QMK432 B7104□MHT	250	X7R	0.1 μ	±10, ±20	2.5	150	2.5±0.20		
MMASQ45MSB7224□TNA01	QMK432 B7224□MHT		X7R	0.22 μ	±10, ±20	2.5	150	2.5±0.20		
MMASQ45MSB7334□TNA01	QMK432 B7334□MHT		X7R	0.33 μ	±10, ±20	2.5	150	2.5±0.20		
MMASQ45MSB7474□TNA01	QMK432 B7474□MHT		X7R	0.47 μ	±10, ±20	2.5	150	2.5±0.20		
MMASS45MSB7473□TNA01	SMK432 B7473□MHT		630	X7R	0.047 μ	±10, ±20	2.5	120	2.5±0.20	
MMASS45MSB7683□TNA01	SMK432 B7683□MHT			X7R	0.068 μ	±10, ±20	2.5	120	2.5±0.20	
MMASS45MSB7104□TNA01	SMK432 B7104□MHT	X7R		0.1 μ	±10, ±20	2.5	120	2.5±0.20		

■ PART NUMBER

High frequency/Low loss Medium-High Voltage Multilayer Ceramic Capacitors for Medical Devices classified as GHTF Class C (Japan Class III)

● 1005TYPE

【Temperature Characteristic CG : CG/C0G (−55~+125°C)】 0.5mm Thickness

New part number	Old part number (for reference)	Rated voltage [V]	Temperature characteristics		Capacitance [F]	Capacitance tolerance	Q [at 1MHz] (Min)	HTLT	Thickness*1 [mm]	Note
								Rated voltage x %		
MMARQ105SCG0R5[FRA01	QVS105 CG0R5[VHF	250	CG	C0G	0.5 p	±0.1pF, ±0.25pF	810	200	0.5±0.05	
MMARQ105SCG0R6[FRA01	QVS105 CG0R6[VHF		CG	C0G	0.6 p	±0.1pF, ±0.25pF	812	200	0.5±0.05	
MMARQ105SCG0R7[FRA01	QVS105 CG0R7[VHF		CG	C0G	0.7 p	±0.1pF, ±0.25pF	814	200	0.5±0.05	
MMARQ105SCG0R75[FRA01	QVS105 CG0R75[VHF		CG	C0G	0.75 p	±0.1pF, ±0.25pF	815	200	0.5±0.05	
MMARQ105SCG0R8[FRA01	QVS105 CG0R8[VHF		CG	C0G	0.8 p	±0.1pF, ±0.25pF	816	200	0.5±0.05	
MMARQ105SCG0R9[FRA01	QVS105 CG0R9[VHF		CG	C0G	0.9 p	±0.1pF, ±0.25pF	818	200	0.5±0.05	
MMARQ105SCG010[FRA01	QVS105 CG010[VHF		CG	C0G	1 p	±0.1pF, ±0.25pF	820	200	0.5±0.05	
MMARQ105SCG1R1[FRA01	QVS105 CG1R1[VHF		CG	C0G	1.1 p	±0.1pF, ±0.25pF	822	200	0.5±0.05	
MMARQ105SCG1R2[FRA01	QVS105 CG1R2[VHF		CG	C0G	1.2 p	±0.1pF, ±0.25pF	824	200	0.5±0.05	
MMARQ105SCG1R3[FRA01	QVS105 CG1R3[VHF		CG	C0G	1.3 p	±0.1pF, ±0.25pF	826	200	0.5±0.05	
MMARQ105SCG1R5[FRA01	QVS105 CG1R5[VHF		CG	C0G	1.5 p	±0.1pF, ±0.25pF	830	200	0.5±0.05	
MMARQ105SCG1R6[FRA01	QVS105 CG1R6[VHF		CG	C0G	1.6 p	±0.1pF, ±0.25pF	832	200	0.5±0.05	
MMARQ105SCG1R8[FRA01	QVS105 CG1R8[VHF		CG	C0G	1.8 p	±0.1pF, ±0.25pF	836	200	0.5±0.05	
MMARQ105SCG020[FRA01	QVS105 CG020[VHF		CG	C0G	2 p	±0.1pF, ±0.25pF	840	200	0.5±0.05	
MMARQ105SCG2R2[FRA01	QVS105 CG2R2[VHF		CG	C0G	2.2 p	±0.1pF, ±0.25pF	844	200	0.5±0.05	
MMARQ105SCG2R4[FRA01	QVS105 CG2R4[VHF		CG	C0G	2.4 p	±0.1pF, ±0.25pF	848	200	0.5±0.05	
MMARQ105SCG2R7[FRA01	QVS105 CG2R7[VHF		CG	C0G	2.7 p	±0.1pF, ±0.25pF	854	200	0.5±0.05	
MMARQ105SCG030[FRA01	QVS105 CG030[VHF		CG	C0G	3 p	±0.1pF, ±0.25pF	860	200	0.5±0.05	
MMARQ105SCG3R3[FRA01	QVS105 CG3R3[VHF		CG	C0G	3.3 p	±0.1pF, ±0.25pF	866	200	0.5±0.05	
MMARQ105SCG3R6[FRA01	QVS105 CG3R6[VHF		CG	C0G	3.6 p	±0.1pF, ±0.25pF	872	200	0.5±0.05	
MMARQ105SCG3R9[FRA01	QVS105 CG3R9[VHF		CG	C0G	3.9 p	±0.1pF, ±0.25pF	878	200	0.5±0.05	
MMARQ105SCG4R3[FRA01	QVS105 CG4R3[VHF		CG	C0G	4.3 p	±0.1pF, ±0.25pF	886	200	0.5±0.05	
MMARQ105SCG4R7[FRA01	QVS105 CG4R7[VHF		CG	C0G	4.7 p	±0.1pF, ±0.25pF	894	200	0.5±0.05	
MMARQ105SCG5R1[FRA01	QVS105 CG5R1[VHF		CG	C0G	5.1 p	±0.25pF, ±0.5pF	902	200	0.5±0.05	
MMARQ105SCG5R6[FRA01	QVS105 CG5R6[VHF		CG	C0G	5.6 p	±0.25pF, ±0.5pF	912	200	0.5±0.05	
MMARQ105SCG6R2[FRA01	QVS105 CG6R2[VHF		CG	C0G	6.2 p	±0.25pF, ±0.5pF	924	200	0.5±0.05	
MMARQ105SCG6R8[FRA01	QVS105 CG6R8[VHF		CG	C0G	6.8 p	±0.25pF, ±0.5pF	936	200	0.5±0.05	
MMARQ105SCG7R5[FRA01	QVS105 CG7R5[VHF		CG	C0G	7.5 p	±0.25pF, ±0.5pF	950	200	0.5±0.05	
MMARQ105SCG8R2[FRA01	QVS105 CG8R2[VHF		CG	C0G	8.2 p	±0.25pF, ±0.5pF	964	200	0.5±0.05	
MMARQ105SCG9R1[FRA01	QVS105 CG9R1[VHF		CG	C0G	9.1 p	±0.25pF, ±0.5pF	982	200	0.5±0.05	
MMARQ105SCG100JFRA01	QVS105 CG100JVHF		CG	C0G	10 p	±5%	1000	200	0.5±0.05	
MMARQ105SCG110JFRA01	QVS105 CG110JVHF		CG	C0G	11 p	±5%	1020	200	0.5±0.05	
MMARQ105SCG120JFRA01	QVS105 CG120JVHF		CG	C0G	12 p	±5%	1040	200	0.5±0.05	
MMARQ105SCG130JFRA01	QVS105 CG130JVHF		CG	C0G	13 p	±5%	1060	200	0.5±0.05	
MMARQ105SCG150JFRA01	QVS105 CG150JVHF		CG	C0G	15 p	±5%	1100	200	0.5±0.05	
MMARQ105SCG160JFRA01	QVS105 CG160JVHF		CG	C0G	16 p	±5%	1120	200	0.5±0.05	
MMARQ105SCG180JFRA01	QVS105 CG180JVHF		CG	C0G	18 p	±5%	1160	200	0.5±0.05	
MMARQ105SCG200JFRA01	QVS105 CG200JVHF		CG	C0G	20 p	±5%	1200	200	0.5±0.05	
MMARQ105SCG220JFRA01	QVS105 CG220JVHF		CG	C0G	22 p	±5%	1240	200	0.5±0.05	
MMARQ105SCG240JFRA01	QVS105 CG240JVHF		CG	C0G	24 p	±5%	1280	200	0.5±0.05	
MMARQ105SCG270JFRA01	QVS105 CG270JVHF		CG	C0G	27 p	±5%	1340	200	0.5±0.05	
MMARQ105SCG300JFRA01	QVS105 CG300JVHF		CG	C0G	30 p	±5%	1400	200	0.5±0.05	
MMARQ105SCG330JFRA01	QVS105 CG330JVHF		CG	C0G	33 p	±5%	1400	200	0.5±0.05	

▶ This catalog contains the typical specification only due to the limitation of space. When you consider the purchase of our products, please check our specification.
For details of each product (characteristics graph, reliability information, precautions for use, and so on), see our Web site (<http://www.ty-top.com/>).

■ PART NUMBER

● 1608TYPE

【Temperature Characteristic CG : CG/C0G (−55~+125°C)】 0.7mm Thickness

New part number	Old part number (for reference)	Rated voltage [V]	Temperature characteristics		Capacitance [F]	Capacitance tolerance	Q [at 1MHz] (Min)	HTLT	Thickness*1 [mm]	Note
								Rated voltage x %		
MMARQ167SCG0R2□TRA01	QVS107 CG0R2□CHT	250	CG	C0G	0.2 p	±0.05pF, ±0.1pF	804	200	0.7±0.10	
MMARQ167SCG0R3□TRA01	QVS107 CG0R3□CHT		CG	C0G	0.3 p	±0.05pF, ±0.1pF	806	200	0.7±0.10	
MMARQ167SCG0R4□TRA01	QVS107 CG0R4□CHT		CG	C0G	0.4 p	±0.05pF, ±0.1pF	808	200	0.7±0.10	
MMARQ167SCG0R5□TRA01	QVS107 CG0R5□CHT		CG	C0G	0.5 p	±0.1pF, ±0.25pF	810	200	0.7±0.10	
MMARQ167SCG0R6□TRA01	QVS107 CG0R6□CHT		CG	C0G	0.6 p	±0.1pF, ±0.25pF	812	200	0.7±0.10	
MMARQ167SCG0R7□TRA01	QVS107 CG0R7□CHT		CG	C0G	0.7 p	±0.1pF, ±0.25pF	814	200	0.7±0.10	
MMARQ167SCGR75□TRA01	QVS107 CGR75□CHT		CG	C0G	0.75 p	±0.1pF, ±0.25pF	815	200	0.7±0.10	
MMARQ167SCG0R8□TRA01	QVS107 CG0R8□CHT		CG	C0G	0.8 p	±0.1pF, ±0.25pF	816	200	0.7±0.10	
MMARQ167SCG0R9□TRA01	QVS107 CG0R9□CHT		CG	C0G	0.9 p	±0.1pF, ±0.25pF	818	200	0.7±0.10	
MMARQ167SCG010□TRA01	QVS107 CG010□CHT		CG	C0G	1 p	±0.1pF, ±0.25pF	820	200	0.7±0.10	
MMARQ167SCG1R1□TRA01	QVS107 CG1R1□CHT		CG	C0G	1.1 p	±0.1pF, ±0.25pF	822	200	0.7±0.10	
MMARQ167SCG1R2□TRA01	QVS107 CG1R2□CHT		CG	C0G	1.2 p	±0.1pF, ±0.25pF	824	200	0.7±0.10	
MMARQ167SCG1R3□TRA01	QVS107 CG1R3□CHT		CG	C0G	1.3 p	±0.1pF, ±0.25pF	826	200	0.7±0.10	
MMARQ167SCG1R5□TRA01	QVS107 CG1R5□CHT		CG	C0G	1.5 p	±0.1pF, ±0.25pF	830	200	0.7±0.10	
MMARQ167SCG1R6□TRA01	QVS107 CG1R6□CHT		CG	C0G	1.6 p	±0.1pF, ±0.25pF	832	200	0.7±0.10	
MMARQ167SCG1R8□TRA01	QVS107 CG1R8□CHT		CG	C0G	1.8 p	±0.1pF, ±0.25pF	836	200	0.7±0.10	
MMARQ167SCG020□TRA01	QVS107 CG020□CHT		CG	C0G	2 p	±0.1pF, ±0.25pF	840	200	0.7±0.10	
MMARQ167SCG2R2□TRA01	QVS107 CG2R2□CHT		CG	C0G	2.2 p	±0.1pF, ±0.25pF	844	200	0.7±0.10	
MMARQ167SCG2R4□TRA01	QVS107 CG2R4□CHT		CG	C0G	2.4 p	±0.1pF, ±0.25pF	848	200	0.7±0.10	
MMARQ167SCG2R7□TRA01	QVS107 CG2R7□CHT		CG	C0G	2.7 p	±0.1pF, ±0.25pF	854	200	0.7±0.10	
MMARQ167SCG030□TRA01	QVS107 CG030□CHT		CG	C0G	3 p	±0.1pF, ±0.25pF	860	200	0.7±0.10	
MMARQ167SCG3R3□TRA01	QVS107 CG3R3□CHT		CG	C0G	3.3 p	±0.1pF, ±0.25pF	866	200	0.7±0.10	
MMARQ167SCG3R6□TRA01	QVS107 CG3R6□CHT		CG	C0G	3.6 p	±0.1pF, ±0.25pF	872	200	0.7±0.10	
MMARQ167SCG3R9□TRA01	QVS107 CG3R9□CHT		CG	C0G	3.9 p	±0.1pF, ±0.25pF	878	200	0.7±0.10	
MMARQ167SCG4R3□TRA01	QVS107 CG4R3□CHT		CG	C0G	4.3 p	±0.1pF, ±0.25pF	886	200	0.7±0.10	
MMARQ167SCG4R7□TRA01	QVS107 CG4R7□CHT		CG	C0G	4.7 p	±0.1pF, ±0.25pF	894	200	0.7±0.10	
MMARQ167SCG5R1□TRA01	QVS107 CG5R1□CHT		CG	C0G	5.1 p	±0.25pF, ±0.5pF	902	200	0.7±0.10	
MMARQ167SCG5R6□TRA01	QVS107 CG5R6□CHT		CG	C0G	5.6 p	±0.25pF, ±0.5pF	912	200	0.7±0.10	
MMARQ167SCG6R2□TRA01	QVS107 CG6R2□CHT		CG	C0G	6.2 p	±0.25pF, ±0.5pF	924	200	0.7±0.10	
MMARQ167SCG6R8□TRA01	QVS107 CG6R8□CHT		CG	C0G	6.8 p	±0.25pF, ±0.5pF	936	200	0.7±0.10	
MMARQ167SCG7R5□TRA01	QVS107 CG7R5□CHT		CG	C0G	7.5 p	±0.25pF, ±0.5pF	950	200	0.7±0.10	
MMARQ167SCG8R2□TRA01	QVS107 CG8R2□CHT		CG	C0G	8.2 p	±0.25pF, ±0.5pF	964	200	0.7±0.10	
MMARQ167SCG9R1□TRA01	QVS107 CG9R1□CHT		CG	C0G	9.1 p	±0.25pF, ±0.5pF	982	200	0.7±0.10	
MMARQ167SCG100□TRA01	QVS107 CG100□CHT		CG	C0G	10 p	±2%, ±5%	1000	200	0.7±0.10	
MMARQ167SCG110JTRA01	QVS107 CG110JCHT		CG	C0G	11 p	±5%	1020	200	0.7±0.10	
MMARQ167SCG120JTRA01	QVS107 CG120JCHT		CG	C0G	12 p	±5%	1040	200	0.7±0.10	
MMARQ167SCG130JTRA01	QVS107 CG130JCHT		CG	C0G	13 p	±5%	1060	200	0.7±0.10	
MMARQ167SCG150JTRA01	QVS107 CG150JCHT		CG	C0G	15 p	±5%	1100	200	0.7±0.10	
MMARQ167SCG160JTRA01	QVS107 CG160JCHT		CG	C0G	16 p	±5%	1120	200	0.7±0.10	
MMARQ167SCG180JTRA01	QVS107 CG180JCHT		CG	C0G	18 p	±5%	1160	200	0.7±0.10	
MMARQ167SCG200JTRA01	QVS107 CG200JCHT		CG	C0G	20 p	±5%	1200	200	0.7±0.10	
MMARQ167SCG220JTRA01	QVS107 CG220JCHT		CG	C0G	22 p	±5%	1240	200	0.7±0.10	
MMARQ167SCG240JTRA01	QVS107 CG240JCHT		CG	C0G	24 p	±5%	1280	200	0.7±0.10	
MMARQ167SCG270JTRA01	QVS107 CG270JCHT		CG	C0G	27 p	±5%	1340	200	0.7±0.10	
MMARQ167SCG300JTRA01	QVS107 CG300JCHT		CG	C0G	30 p	±5%	1400	200	0.7±0.10	
MMARQ167SCG330JTRA01	QVS107 CG330JCHT		CG	C0G	33 p	±5%	1400	200	0.7±0.10	
MMARQ167SCG360JTRA01	QVS107 CG360JCHT		CG	C0G	36 p	±5%	1400	200	0.7±0.10	
MMARQ167SCG390JTRA01	QVS107 CG390JCHT		CG	C0G	39 p	±5%	1400	200	0.7±0.10	
MMARQ167SCG430JTRA01	QVS107 CG430JCHT		CG	C0G	43 p	±5%	1400	200	0.7±0.10	
MMARQ167SCG470JTRA01	QVS107 CG470JCHT		CG	C0G	47 p	±5%	1400	200	0.7±0.10	
MMARQ167SCG510JTRA01	QVS107 CG510JCHT		CG	C0G	51 p	±5%	1400	200	0.7±0.10	
MMARQ167SCG560JTRA01	QVS107 CG560JCHT		CG	C0G	56 p	±5%	1400	200	0.7±0.10	
MMARQ167SCG620JTRA01	QVS107 CG620JCHT		CG	C0G	62 p	±5%	1400	200	0.7±0.10	
MMARQ167SCG680JTRA01	QVS107 CG680JCHT		CG	C0G	68 p	±5%	1400	200	0.7±0.10	
MMARQ167SCG750JTRA01	QVS107 CG750JCHT		CG	C0G	75 p	±5%	1400	200	0.7±0.10	
MMARQ167SCG820JTRA01	QVS107 CG820JCHT		CG	C0G	82 p	±5%	1400	200	0.7±0.10	
MMARQ167SCG910JTRA01	QVS107 CG910JCHT		CG	C0G	91 p	±5%	1400	200	0.7±0.10	
MMARQ167SCG101JTRA01	QVS107 CG101JCHT		CG	C0G	100 p	±5%	1400	200	0.7±0.10	

▶ This catalog contains the typical specification only due to the limitation of space. When you consider the purchase of our products, please check our specification.
For details of each product (characteristics graph, reliability information, precautions for use, and so on), see our Web site (<http://www.ty-top.com/>).

PART NUMBER

2012TYPE

【Temperature Characteristic CG : CG/C0G (−55~+125°C)】 0.85mm Thickness

New part number	Old part number (for reference)	Rated voltage [V]	Temperature characteristics		Capacitance [F]	Capacitance tolerance	Q [at 1MHz] (Min)	HTLT	Thickness*1 [mm]	Note
								Rated voltage x %		
MMARQ219SCG0R3□TRA01	QVS212 CG0R3□DHT	250	CG	C0G	0.3 p	±0.1pF, ±0.25pF, ±0.5pF	806	200	0.85±0.10	
MMARQ219SCG0R4□TRA01	QVS212 CG0R4□DHT		CG	C0G	0.4 p	±0.1pF, ±0.25pF, ±0.5pF	808	200	0.85±0.10	
MMARQ219SCG0R5□TRA01	QVS212 CG0R5□DHT		CG	C0G	0.5 p	±0.1pF, ±0.25pF	810	200	0.85±0.10	
MMARQ219SCG0R6□TRA01	QVS212 CG0R6□DHT		CG	C0G	0.6 p	±0.1pF, ±0.25pF	812	200	0.85±0.10	
MMARQ219SCG0R7□TRA01	QVS212 CG0R7□DHT		CG	C0G	0.7 p	±0.1pF, ±0.25pF	814	200	0.85±0.10	
MMARQ219SCG0R75□TRA01	QVS212 CGR75□DHT		CG	C0G	0.75 p	±0.1pF, ±0.25pF	815	200	0.85±0.10	
MMARQ219SCG0R8□TRA01	QVS212 CG0R8□DHT		CG	C0G	0.8 p	±0.1pF, ±0.25pF	816	200	0.85±0.10	
MMARQ219SCG0R9□TRA01	QVS212 CG0R9□DHT		CG	C0G	0.9 p	±0.1pF, ±0.25pF	818	200	0.85±0.10	
MMARQ219SCG010□TRA01	QVS212 CG010□DHT		CG	C0G	1 p	±0.1pF, ±0.25pF	820	200	0.85±0.10	
MMARQ219SCG1R1□TRA01	QVS212 CG1R1□DHT		CG	C0G	1.1 p	±0.1pF, ±0.25pF	822	200	0.85±0.10	
MMARQ219SCG1R2□TRA01	QVS212 CG1R2□DHT		CG	C0G	1.2 p	±0.1pF, ±0.25pF	824	200	0.85±0.10	
MMARQ219SCG1R3□TRA01	QVS212 CG1R3□DHT		CG	C0G	1.3 p	±0.1pF, ±0.25pF	826	200	0.85±0.10	
MMARQ219SCG1R5□TRA01	QVS212 CG1R5□DHT		CG	C0G	1.5 p	±0.1pF, ±0.25pF	830	200	0.85±0.10	
MMARQ219SCG1R6□TRA01	QVS212 CG1R6□DHT		CG	C0G	1.6 p	±0.1pF, ±0.25pF	832	200	0.85±0.10	
MMARQ219SCG1R8□TRA01	QVS212 CG1R8□DHT		CG	C0G	1.8 p	±0.1pF, ±0.25pF	836	200	0.85±0.10	
MMARQ219SCG020□TRA01	QVS212 CG020□DHT		CG	C0G	2 p	±0.1pF, ±0.25pF	840	200	0.85±0.10	
MMARQ219SCG2R2□TRA01	QVS212 CG2R2□DHT		CG	C0G	2.2 p	±0.1pF, ±0.25pF	844	200	0.85±0.10	
MMARQ219SCG2R4□TRA01	QVS212 CG2R4□DHT		CG	C0G	2.4 p	±0.1pF, ±0.25pF	848	200	0.85±0.10	
MMARQ219SCG2R7□TRA01	QVS212 CG2R7□DHT		CG	C0G	2.7 p	±0.1pF, ±0.25pF	854	200	0.85±0.10	
MMARQ219SCG030□TRA01	QVS212 CG030□DHT		CG	C0G	3 p	±0.1pF, ±0.25pF	860	200	0.85±0.10	
MMARQ219SCG3R3□TRA01	QVS212 CG3R3□DHT		CG	C0G	3.3 p	±0.1pF, ±0.25pF	866	200	0.85±0.10	
MMARQ219SCG3R6□TRA01	QVS212 CG3R6□DHT		CG	C0G	3.6 p	±0.1pF, ±0.25pF	872	200	0.85±0.10	
MMARQ219SCG3R9□TRA01	QVS212 CG3R9□DHT		CG	C0G	3.9 p	±0.1pF, ±0.25pF	878	200	0.85±0.10	
MMARQ219SCG4R3□TRA01	QVS212 CG4R3□DHT		CG	C0G	4.3 p	±0.1pF, ±0.25pF	886	200	0.85±0.10	
MMARQ219SCG4R7□TRA01	QVS212 CG4R7□DHT		CG	C0G	4.7 p	±0.1pF, ±0.25pF	894	200	0.85±0.10	
MMARQ219SCG5R1□TRA01	QVS212 CG5R1□DHT		CG	C0G	5.1 p	±0.25pF, ±0.5pF	902	200	0.85±0.10	
MMARQ219SCG5R6□TRA01	QVS212 CG5R6□DHT		CG	C0G	5.6 p	±0.25pF, ±0.5pF	912	200	0.85±0.10	
MMARQ219SCG6R2□TRA01	QVS212 CG6R2□DHT		CG	C0G	6.2 p	±0.25pF, ±0.5pF	924	200	0.85±0.10	
MMARQ219SCG6R8□TRA01	QVS212 CG6R8□DHT		CG	C0G	6.8 p	±0.25pF, ±0.5pF	936	200	0.85±0.10	
MMARQ219SCG7R5□TRA01	QVS212 CG7R5□DHT		CG	C0G	7.5 p	±0.25pF, ±0.5pF	950	200	0.85±0.10	
MMARQ219SCG8R2□TRA01	QVS212 CG8R2□DHT		CG	C0G	8.2 p	±0.25pF, ±0.5pF	964	200	0.85±0.10	
MMARQ219SCG9R1□TRA01	QVS212 CG9R1□DHT		CG	C0G	9.1 p	±0.25pF, ±0.5pF	982	200	0.85±0.10	
MMARQ219SCG100JTRA01	QVS212 CG100JDHT		CG	C0G	10 p	±5%	1000	200	0.85±0.10	
MMARQ219SCG110JTRA01	QVS212 CG110JDHT		CG	C0G	11 p	±5%	1020	200	0.85±0.10	
MMARQ219SCG120JTRA01	QVS212 CG120JDHT		CG	C0G	12 p	±5%	1040	200	0.85±0.10	
MMARQ219SCG130JTRA01	QVS212 CG130JDHT		CG	C0G	13 p	±5%	1060	200	0.85±0.10	
MMARQ219SCG150JTRA01	QVS212 CG150JDHT		CG	C0G	15 p	±5%	1100	200	0.85±0.10	
MMARQ219SCG160JTRA01	QVS212 CG160JDHT		CG	C0G	16 p	±5%	1120	200	0.85±0.10	
MMARQ219SCG180JTRA01	QVS212 CG180JDHT		CG	C0G	18 p	±5%	1160	200	0.85±0.10	
MMARQ219SCG200JTRA01	QVS212 CG200JDHT		CG	C0G	20 p	±5%	1200	200	0.85±0.10	
MMARQ219SCG220JTRA01	QVS212 CG220JDHT		CG	C0G	22 p	±5%	1240	200	0.85±0.10	
MMARQ219SCG240JTRA01	QVS212 CG240JDHT		CG	C0G	24 p	±5%	1280	200	0.85±0.10	
MMARQ219SCG270JTRA01	QVS212 CG270JDHT		CG	C0G	27 p	±5%	1340	200	0.85±0.10	
MMARQ219SCG300JTRA01	QVS212 CG300JDHT		CG	C0G	30 p	±5%	1400	200	0.85±0.10	
MMARQ219SCG330JTRA01	QVS212 CG330JDHT		CG	C0G	33 p	±5%	1400	200	0.85±0.10	
MMARQ219SCG360JTRA01	QVS212 CG360JDHT		CG	C0G	36 p	±5%	1400	200	0.85±0.10	
MMARQ219SCG390JTRA01	QVS212 CG390JDHT		CG	C0G	39 p	±5%	1400	200	0.85±0.10	
MMARQ219SCG430JTRA01	QVS212 CG430JDHT		CG	C0G	43 p	±5%	1400	200	0.85±0.10	
MMARQ219SCG470JTRA01	QVS212 CG470JDHT		CG	C0G	47 p	±5%	1400	200	0.85±0.10	
MMARQ219SCG510JTRA01	QVS212 CG510JDHT		CG	C0G	51 p	±5%	1400	200	0.85±0.10	
MMARQ219SCG560JTRA01	QVS212 CG560JDHT		CG	C0G	56 p	±5%	1400	200	0.85±0.10	
MMARQ219SCG620JTRA01	QVS212 CG620JDHT		CG	C0G	62 p	±5%	1400	200	0.85±0.10	
MMARQ219SCG680JTRA01	QVS212 CG680JDHT		CG	C0G	68 p	±5%	1400	200	0.85±0.10	
MMARQ219SCG750JTRA01	QVS212 CG750JDHT		CG	C0G	75 p	±5%	1400	200	0.85±0.10	
MMARQ219SCG820JTRA01	QVS212 CG820JDHT		CG	C0G	82 p	±5%	1400	200	0.85±0.10	
MMARQ219SCG910JTRA01	QVS212 CG910JDHT		CG	C0G	91 p	±5%	1400	200	0.85±0.10	
MMARQ219SCG101JTRA01	QVS212 CG101JDHT	CG	C0G	100 p	±5%	1400	200	0.85±0.10		

▶ This catalog contains the typical specification only due to the limitation of space. When you consider the purchase of our products, please check our specification.
For details of each product (characteristics graph, reliability information, precautions for use, and so on), see our Web site (<http://www.ty-top.com/>).

■ PART NUMBER

Soft Termination Multilayer Ceramic Capacitors for Medical Devices classified as GHTF Class C (Japan Class III)

● 1608TYPE

【Temperature Characteristic B7 : X7R (−55~+125°C)】 0.8mm Thickness

New part number	Old part number (for reference)	Rated voltage [V]	Temperature characteristics	Capacitance [F]	Capacitance tolerance [%]	tan δ [%]	HTLT	Thickness*1 [mm]	Note
							Rated voltage x %		
MMJCT168BB7473 TPA01	TMJ107BB7473 AHT	25	X7R	0.047 μ	±10, ±20	3.5	200	0.8+0.20/-0	
MMJCT168BB7104 TPA01	TMJ107BB7104 AHT		X7R	0.1 μ	±10, ±20	3.5	200	0.8+0.20/-0	
MMJCT168BB7224 TPA01	TMJ107BB7224 AHT		X7R	0.22 μ	±10, ±20	10	150	0.8+0.20/-0	
MMJCT168BB7474 TPA01	TMJ107BB7474 AHT		X7R	0.47 μ	±10, ±20	10	150	0.8+0.20/-0	
MMJCT168CB7105 RPA01	TMJ107CB7105 AHR	35	X7R	1 μ	±10, ±20	10	150	0.8+0.25/-0	
MMJCG168BB7473 TPA01	GMJ107BB7473 AHT		X7R	0.047 μ	±10, ±20	3.5	200	0.8+0.20/-0	
MMJCG168BB7104 TPA01	GMJ107BB7104 AHT		X7R	0.1 μ	±10, ±20	3.5	200	0.8+0.20/-0	
MMJCG168BB7224 TPA01	GMJ107BB7224 AHT		X7R	0.22 μ	±10, ±20	10	150	0.8+0.20/-0	
MMJCG168BB7474 TPA01	GMJ107BB7474 AHT	50	X7R	0.47 μ	±10, ±20	10	150	0.8+0.20/-0	
MMJCG168CB7105 RPA01	GMJ107CB7105 AHR		X7R	1 μ	±10, ±20	10	150	0.8+0.25/-0	
MMJCU168AB7102 TPA01	UMJ107AB7102 AHT		X7R	1000 p	±10, ±20	3.5	200	0.8+0.15/-0.05	
MMJCU168AB7222 TPA01	UMJ107AB7222 AHT		X7R	2200 p	±10, ±20	3.5	200	0.8+0.15/-0.05	
MMJCU168BB7472 TPA01	UMJ107BB7472 AHT	100	X7R	4700 p	±10, ±20	3.5	200	0.8+0.20/-0	
MMJCU168BB7103 TPA01	UMJ107BB7103 AHT		X7R	0.01 μ	±10, ±20	3.5	200	0.8+0.20/-0	
MMJCU168BB7223 TPA01	UMJ107BB7223 AHT		X7R	0.022 μ	±10, ±20	3.5	200	0.8+0.20/-0	
MMJCU168BB7473 TPA01	UMJ107BB7473 AHT		X7R	0.047 μ	±10, ±20	3.5	200	0.8+0.20/-0	
MMJCH168BB7104 TPA01	HMJ107BB7104 AHT	100	X7R	0.1 μ	±10, ±20	3.5	200	0.8+0.20/-0	
MMJCH168AB7102 TPA01	HMJ107AB7102 AHT		X7R	1000 p	±10, ±20	3.5	200	0.8+0.15/-0.05	
MMJCH168AB7222 TPA01	HMJ107AB7222 AHT		X7R	2200 p	±10, ±20	3.5	200	0.8+0.15/-0.05	
MMJCH168BB7472 TPA01	HMJ107BB7472 AHT		X7R	4700 p	±10, ±20	3.5	200	0.8+0.20/-0	
MMJCH168BB7103 TPA01	HMJ107BB7103 AHT	100	X7R	0.01 μ	±10, ±20	3.5	200	0.8+0.20/-0	
MMJCH168BB7223 TPA01	HMJ107BB7223 AHT		X7R	0.022 μ	±10, ±20	3.5	200	0.8+0.20/-0	
MMJCH168BB7473 TPA01	HMJ107BB7473 AHT		X7R	0.047 μ	±10, ±20	3.5	200	0.8+0.20/-0	
MMJCH168BB7104 TPA01	HMJ107BB7104 AHT		X7R	0.1 μ	±10, ±20	3.5	200	0.8+0.20/-0	

● 2012TYPE

【Temperature Characteristic B7 : X7R (−55~+125°C), C7 : X7S (−55~+125°C)】 0.85mm Thickness (D), 1.25mm Thickness (G)

New part number	Old part number (for reference)	Rated voltage [V]	Temperature characteristics	Capacitance [F]	Capacitance tolerance [%]	tan δ [%]	HTLT	Thickness*1 [mm]	Note
							Rated voltage x %		
MMJJC21GCB7106 TPA01	JMJ212CB7106 GHT	6.3	X7R	10 μ	±10, ±20	10	150	1.25+0.25/-0	
MMJCE21GCB7225 TPA01	EMJ212CB7225 GHT	16	X7R	2.2 μ	±10, ±20	10	150	1.25+0.25/-0	
MMJCE21GCB7475 TPA01	EMJ212CB7475 GHT		X7R	4.7 μ	±10, ±20	10	150	1.25+0.25/-0	
MMJCT21GCB7225 TPA01	TMJ212CB7225 GHT	25	X7R	2.2 μ	±10, ±20	10	150	1.25+0.25/-0	
MMJCG21GCB7105 TPA01	GMJ212CB7105 GHT	35	X7R	1 μ	±10, ±20	10	150	1.25+0.25/-0	
MMJCU21GCB7103 TPA01	UMJ212BB7103 GHT	50	X7R	0.01 μ	±10, ±20	3.5	200	1.25+0.20/-0	
MMJCU21GCB7223 TPA01	UMJ212BB7223 GHT		X7R	0.022 μ	±10, ±20	3.5	200	1.25+0.20/-0	
MMJCU21GCB7473 TPA01	UMJ212BB7473 GHT		X7R	0.047 μ	±10, ±20	3.5	200	1.25+0.20/-0	
MMJCU21GCB7104 TPA01	UMJ212BB7104 GHT		X7R	0.1 μ	±10, ±20	3.5	200	1.25+0.20/-0	
MMJCU21GCB7224 TPA01	UMJ212BB7224 GHT	100	X7R	0.22 μ	±10, ±20	3.5	200	1.25+0.20/-0	
MMJCU21GCC7474 TDA01	UMJ212CC7474 GHTE		X7S	0.47 μ	±10, ±20	3.5	150	1.25+0.25/-0	
MMJCU21GCB7105 TPA01	UMJ212CB7105 GHT		X7R	1 μ	±10, ±20	10	150	1.25+0.25/-0	
MMJCH219NB7102 TPA01	HMJ212KB7102 DHT		X7R	1000 p	±10, ±20	3.5	200	0.85±0.15	
MMJCH219NB7222 TPA01	HMJ212KB7222 DHT	100	X7R	2200 p	±10, ±20	3.5	200	0.85±0.15	
MMJCH21GCB7472 TPA01	HMJ212BB7472 GHT		X7R	4700 p	±10, ±20	3.5	200	1.25+0.20/-0	
MMJCH21GCB7103 TPA01	HMJ212BB7103 GHT		X7R	0.01 μ	±10, ±20	3.5	200	1.25+0.20/-0	
MMJCH21GCB7223 TPA01	HMJ212BB7223 GHT		X7R	0.022 μ	±10, ±20	3.5	200	1.25+0.20/-0	
MMJCH21GCB7473 TPA01	HMJ212BB7473 GHT	250	X7R	0.047 μ	±10, ±20	3.5	200	1.25+0.20/-0	
MMJCH21GCB7104 TPA01	HMJ212BB7104 GHT		X7R	0.1 μ	±10, ±20	3.5	200	1.25+0.20/-0	
MMJCH21GCB7224 TPA01	HMJ212BB7224 GHT		X7R	0.22 μ	±10, ±20	3.5	200	1.25+0.20/-0	
MMJCH21GCC7474 TDA01	HMJ212CC7474 GHTE		X7S	0.47 μ	±10, ±20	3.5	150	1.25+0.25/-0	
MMJCH21GDC7105 TDA01	HMJ212DC7105 GHTE	250	X7S	1 μ	±10, ±20	3.5	150	1.25+0.30/-0	
MMJQC219NB7102 TPA01	QMJ212KB7102 DHT		X7R	1000 p	±10, ±20	2.5	150	0.85±0.15	
MMJQC219NB7222 TPA01	QMJ212KB7222 DHT		X7R	2200 p	±10, ±20	2.5	150	0.85±0.15	
MMJQC21GCB7472 TPA01	QMJ212BB7472 GHT		X7R	4700 p	±10, ±20	2.5	150	1.25+0.20/-0	
MMJQC21GCB7103 TPA01	QMJ212BB7103 GHT	250	X7R	0.01 μ	±10, ±20	2.5	150	1.25+0.20/-0	
MMJQC21GCB7223 TPA01	QMJ212BB7223 GHT		X7R	0.022 μ	±10, ±20	2.5	150	1.25+0.20/-0	

▶ This catalog contains the typical specification only due to the limitation of space. When you consider the purchase of our products, please check our specification.
For details of each product (characteristics graph, reliability information, precautions for use, and so on), see our Web site (<http://www.ty-top.com/>).

■ PART NUMBER

● 3216TYPE

【Temperature Characteristic B7 : X7R(−55~+125°C), C7 : X7S(−55~+125°C)】 1.15mm Thickness、1.6mm Thickness

New part number	Old part number (for reference)	Rated voltage [V]	Temperature characteristics	Capacitance [F]	Capacitance tolerance [%]	tan δ [%]	HTLT		Thickness*1 [mm]	Note
							Rated voltage x %			
MMJCL31LBB7226TPA01	LMJ316BB7226LHT	10	X7R	22 μ	±10, ±20	10	150		1.6±0.30	
MMJCE31LBB7475TPA01	EMJ316BB7475LHT	16	X7R	4.7 μ	±10, ±20	10	150		1.6±0.30	
MMJCE31LBB7106TPA01	EMJ316BB7106LHT		X7R	10 μ	±10, ±20	10	150		1.6±0.30	
MMJCT31LBB7474TPA01	TMJ316BB7474LHT	25	X7R	0.47 μ	±10, ±20	3.5	200		1.6±0.30	
MMJCT31LBB7475TPA01	TMJ316BB7475LHT		X7R	4.7 μ	±10, ±20	10	150		1.6±0.30	
MMJCT31LBB7106TPA01	TMJ316BB7106LHT	35	X7R	10 μ	±10, ±20	10	150		1.6±0.30	
MMJCG31LBB7474TPA01	GMJ316BB7474LHT		X7R	0.47 μ	±10, ±20	3.5	200		1.6±0.30	
MMJCG31LAB7225TPA01	GMJ316AB7225LHT	50	X7R	2.2 μ	±10, ±20	10	150		1.6±0.20	
MMJCG31LBB7475TPA01	GMJ316BB7475LHT		X7R	4.7 μ	±10, ±20	10	150		1.6±0.30	
MMJCG31LBB7106TPA01	GMJ316BB7106LHT		X7R	10 μ	±10, ±20	10	150		1.6±0.30	
MMJCU31LBB7473TPA01	UMJ316BB7473LHT	630	X7R	0.047 μ	±10, ±20	3.5	200		1.6±0.30	
MMJCU31LBB7104TPA01	UMJ316BB7104LHT		X7R	0.1 μ	±10, ±20	3.5	200		1.6±0.30	
MMJCU31LBB7224TPA01	UMJ316BB7224LHT		X7R	0.22 μ	±10, ±20	3.5	200		1.6±0.30	
MMJCU31LBB7474TPA01	UMJ316BB7474LHT		X7R	0.47 μ	±10, ±20	3.5	200		1.6±0.30	
MMJCU31LBB7105TPA01	UMJ316BB7105LHT		X7R	1 μ	±10, ±20	3.5	200		1.6±0.30	
MMJCU31LAB7225TPA01	UMJ316AB7225LHT		X7R	2.2 μ	±10, ±20	10	150		1.6±0.20	
MMJCU31LBC7475TPA01	UMJ316BC7475LHTE		X7S	4.7 μ	±10, ±20	2.5	150		1.6±0.30	
MMJCH31QHB7102TPA01	HMJ316 B7102FHT		X7R	1000 p	±10, ±20	3.5	200		1.15±0.10	
MMJCH31QHB7222TPA01	HMJ316 B7222FHT		X7R	2200 p	±10, ±20	3.5	200		1.15±0.10	
MMJCH31QHB7472TPA01	HMJ316 B7472FHT		X7R	4700 p	±10, ±20	3.5	200		1.15±0.10	
MMJCH31QAB7103TPA01	HMJ316KB7103FHT	X7R	0.01 μ	±10, ±20	3.5	200		1.15±0.20		
MMJCH31LBB7223TPA01	HMJ316BB7223LHT	100	X7R	0.022 μ	±10, ±20	3.5	200		1.6±0.30	
MMJCH31LBB7473TPA01	HMJ316BB7473LHT		X7R	0.047 μ	±10, ±20	3.5	200		1.6±0.30	
MMJCH31LBB7104TPA01	HMJ316BB7104LHT		X7R	0.1 μ	±10, ±20	3.5	200		1.6±0.30	
MMJCH31LBB7224TPA01	HMJ316BB7224LHT		X7R	0.22 μ	±10, ±20	3.5	200		1.6±0.30	
MMJCH31LBB7474TPA01	HMJ316BB7474LHT		X7R	0.47 μ	±10, ±20	3.5	200		1.6±0.30	
MMJCH31LBB7105TPA01	HMJ316BB7105LHT		X7R	1 μ	±10, ±20	3.5	200		1.6±0.30	
MMJCH31LBC7225TPA01	HMJ316BC7225LHTE		X7S	2.2 μ	±10, ±20	3.5	150		1.6±0.30	
MMJQC31QHB7102TPA01	QMJ316 B7102FHT		X7R	1000 p	±10, ±20	2.5	150		1.15±0.10	
MMJQC31QHB7222TPA01	QMJ316 B7222FHT		X7R	2200 p	±10, ±20	2.5	150		1.15±0.10	
MMJQC31QHB7472TPA01	QMJ316 B7472FHT		X7R	4700 p	±10, ±20	2.5	150		1.15±0.10	
MMJQC31QAB7103TPA01	QMJ316KB7103FHT	X7R	0.01 μ	±10, ±20	2.5	150		1.15±0.20		
MMJQC31LBB7223TPA01	QMJ316BB7223LHT	250	X7R	0.022 μ	±10, ±20	2.5	150		1.6±0.30	
MMJQC31LBB7473TPA01	QMJ316BB7473LHT		X7R	0.047 μ	±10, ±20	2.5	150		1.6±0.30	
MMJQC31LBB7104TPA01	QMJ316BB7104LHT		X7R	0.1 μ	±10, ±20	2.5	150		1.6±0.30	
MMJCS31QHB7102TPA01	SMJ316 B7102FHT		X7R	1000 p	±10, ±20	2.5	120		1.15±0.10	
MMJCS31QHB7222TPA01	SMJ316 B7222FHT		X7R	2200 p	±10, ±20	2.5	120		1.15±0.10	
MMJCS31QHB7472TPA01	SMJ316 B7472FHT		X7R	4700 p	±10, ±20	2.5	120		1.15±0.10	
MMJCS31QAB7103TPA01	SMJ316KB7103FHT		X7R	0.01 μ	±10, ±20	2.5	120		1.15±0.20	
MMJCS31LBB7223TPA01	SMJ316BB7223LHT		X7R	0.022 μ	±10, ±20	2.5	120		1.6±0.30	

● 3225TYPE

【Temperature Characteristic B7 : X7R(−55~+125°C), C7 : X7S(−55~+125°C)】 1.9mm Thickness、2.5mm Thickness

New part number	Old part number (for reference)	Rated voltage [V]	Temperature characteristics	Capacitance [F]	Capacitance tolerance [%]	tan δ [%]	HTLT		Thickness*1 [mm]	Note	
							Rated voltage x %				
MMJJC32MLB7476PPDT1	JMJ325KB7476MHP	6.3	X7R	47 μ	±10, ±20	10	150		2.5±0.30		
MMJCE32MLB7226PPDT1	EMJ325KB7226MHP	16	X7R	22 μ	±10, ±20	10	150		2.5±0.30		
MMJCT32MKB7475PPA01	TMJ325AB7475MHP		X7R	4.7 μ	±10, ±20	5	150		2.5±0.30		
MMJCT32MLB7106PPDT1	TMJ325KB7106MHP	25	X7R	10 μ	±10, ±20	10	150		2.5±0.30		
MMJCG32MKB7475PPA01	GMJ325AB7475MHP		X7R	4.7 μ	±10, ±20	5	150		2.5±0.30		
MMJCG32MLB7106PPDT1	GMJ325KB7106MHP	35	X7R	10 μ	±10, ±20	10	150		2.5±0.30		
MMJCU32MKB7225PPA01	UMJ325AB7225MHP		X7R	2.2 μ	±10, ±20	3.5	200		2.5±0.30		
MMJCU32MKB7475PPA01	UMJ325AB7475MHP	50	X7R	4.7 μ	±10, ±20	5	150		2.5±0.30		
MMJCU32MLB7106PPDT1	UMJ325KB7106MHP		X7R	10 μ	±10, ±20	10	150		2.5±0.30		
MMJCH32NSB7223TPA01	HMJ325 B7223NHT	100	X7R	0.022 μ	±10, ±20	3.5	200		1.9±0.20		
MMJCH32NSB7473TPA01	HMJ325 B7473NHT		X7R	0.047 μ	±10, ±20	3.5	200		1.9±0.20		
MMJCH32NSB7104TPA01	HMJ325 B7104NHT		X7R	0.1 μ	±10, ±20	3.5	200		1.9±0.20		
MMJCH32NSB7224TPA01	HMJ325 B7224NHT		X7R	0.22 μ	±10, ±20	3.5	200		1.9±0.20		
MMJCH32NSB7474TPA01	HMJ325 B7474NHT		X7R	0.47 μ	±10, ±20	3.5	200		1.9±0.20		
MMJCH32NSB7105TPA01	HMJ325 B7105NHT		X7R	1 μ	±10, ±20	3.5	200		1.9±0.20		
MMJCH32MKB7225PPA01	HMJ325AB7225MHP		X7R	2.2 μ	±10, ±20	3.5	200		2.5±0.30		
MMJCH32MLC7475PPDT1	HMJ325KC7475MHPE		X7S	4.7 μ	±10, ±20	3.5	150		2.5±0.30		
MMJQC32NSB7223TPA01	QMJ325 B7223NHT		250	X7R	0.022 μ	±10, ±20	2.5	150		1.9±0.20	
MMJQC32NSB7473TPA01	QMJ325 B7473NHT			X7R	0.047 μ	±10, ±20	2.5	150		1.9±0.20	
MMJQC32NSB7104TPA01	QMJ325 B7104NHT	X7R		0.1 μ	±10, ±20	2.5	150		1.9±0.20		
MMJQC32NSB7224TPA01	QMJ325 B7224NHT	X7R		0.22 μ	±10, ±20	2.5	150		1.9±0.20		
MMJCS32NSB7223TPA01	SMJ325 B7223NHT	630	X7R	0.022 μ	±10, ±20	2.5	120		1.9±0.20		
MMJCS32NSB7473TPA01	SMJ325 B7473NHT		X7R	0.047 μ	±10, ±20	2.5	120		1.9±0.20		

▶ This catalog contains the typical specification only due to the limitation of space. When you consider the purchase of our products, please check our specification.
For details of each product (characteristics graph, reliability information, precautions for use, and so on), see our Web site (<http://www.ty-top.com/>).

PART NUMBER

LW Reversal Decoupling Low ESL Capacitors (LWDC™) for Medical Devices classified as GHTF Class C (Japan Class III)

● 0510TYPE

【Temperature Characteristic B5(BJ) : X5R(−55~+85°C)】 0.3mm Thickness

New part number	Old part number (for reference)	Rated voltage [V]	Temperature characteristics	Capacitance [F]	Capacitance tolerance [%]	tan δ [%]	HTLT	Thickness*1 [mm]	Note
							Rated voltage x %		
MMRLT103SB5104MFNA01	TWK105 BJ104MPHF	25	X5R	0.1 μ	±20	5	150	0.3±0.05	
MMRLE103SB5224MFNA01	EWK105 BJ224MPHF	16	X5R	0.22 μ	±20	10	150	0.3±0.05	
MMRLL103SB5474MFNA01	LWK105 BJ474MPHF	10	X5R	0.47 μ	±20	10	150	0.3±0.05	
MMRLA103SB5105MFNA01	AWK105 BJ105MPHF	4	X5R	1 μ	±20	10	150	0.3±0.05	

【Temperature Characteristic C6 : X6S(−55~+105°C), C7 : X7S(−55~+125°C)】 0.3mm Thickness

New part number	Old part number (for reference)	Rated voltage [V]	Temperature characteristics	Capacitance [F]	Capacitance tolerance [%]	tan δ [%]	HTLT	Thickness*1 [mm]	Note
							Rated voltage x %		
MMRLE103SC6104MFNA01	EWK105 C6104MPHF	16	X6S	0.1 μ	±20	5	150	0.3±0.05	
MMRLL103SC7104MFNA01	LWK105 C7104MPHF	10	X7S	0.1 μ	±20	5	150	0.3±0.05	
MMRLL103SC6224MFNA01	LWK105 C6224MPHF		X6S	0.22 μ	±20	10	150	0.3±0.05	
MMRLJ103SC7104MFNA01	JWK105 C7104MPHF	6.3	X7S	0.1 μ	±20	5	150	0.3±0.05	
MMRLJ103SC7224MFNA01	JWK105 C7224MPHF		X7S	0.22 μ	±20	10	150	0.3±0.05	
MMRLJ103SC6474MFNA01	JWK105 C6474MPHF		X6S	0.47 μ	±20	10	150	0.3±0.05	
MMRLA103SC7224MFNA01	AWK105 C7224MPHF	4	X7S	0.22 μ	±20	10	150	0.3±0.05	
MMRLA103SC6474MFNA01	AWK105 C6474MPHF		X6S	0.47 μ	±20	10	150	0.3±0.05	

● 0816TYPE

【Temperature Characteristic B5(BJ) : X5R(−55~+85°C)】 0.5mm Thickness

New part number	Old part number (for reference)	Rated voltage [V]	Temperature characteristics	Capacitance [F]	Capacitance tolerance [%]	tan δ [%]	HTLT	Thickness*1 [mm]	Note
							Rated voltage x %		
MMRLL165SB5105MTNA01	LWK107 BJ105MVHT	10	X5R	1 μ	±20	10	150	0.5±0.05	
MMRLL165SB5225MTNA01	JWK107 BJ225MVHT	6.3	X5R	2.2 μ	±20	10	150	0.5±0.05	
MMRLJ165SB5475MTNA01	JWK107 BJ475MVHT		X5R	4.7 μ	±20	10	150	0.5±0.05	

【Temperature Characteristic B7 : X7R(−55~+125°C), C6 : X6S(−55~+105°C), C7 : X7S(−55~+125°C)】 0.5mm Thickness

New part number	Old part number (for reference)	Rated voltage [V]	Temperature characteristics	Capacitance [F]	Capacitance tolerance [%]	tan δ [%]	HTLT	Thickness*1 [mm]	Note
							Rated voltage x %		
MMRLT165SB7104MTNA01	TWK107 B7104MVHT	25	X7R	0.1 μ	±20	5	150	0.5±0.05	
MMRLE165SB7224MTNA01	EWK107 B7224MVHT	16	X7R	0.22 μ	±20	5	150	0.5±0.05	
MMRLE165SB7474MTNA01	EWK107 B7474MVHT		X7R	0.47 μ	±20	5	150	0.5±0.05	
MMRLL165SB7474MTNA01	LWK107 B7474MVHT	10	X7R	0.47 μ	±20	5	150	0.5±0.05	
MMRLJ165SC7105MTNA01	JWK107 C7105MVHT	6.3	X7S	1 μ	±20	10	150	0.5±0.05	
MMRLA165SC6225MTNA01	AWK107 C6225MVHT	4	X6S	2.2 μ	±20	10	150	0.5±0.05	
MMRLA165SC6475MTNA01	AWK107 C6475MVHT		X6S	4.7 μ	±20	10	150	0.5±0.05	

● 1220TYPE

【Temperature Characteristic B5(BJ) : X5R(−55~+85°C)】 0.85mm Thickness

New part number	Old part number (for reference)	Rated voltage [V]	Temperature characteristics	Capacitance [F]	Capacitance tolerance [%]	tan δ [%]	HTLT	Thickness*1 [mm]	Note
							Rated voltage x %		
MMRLL219SB5475□TNA01	LWK212 BJ475□DHT	10	X5R	4.7 μ	±10, ±20	10	150	0.85±0.10	
MMRLJ219SB5106MTNA01	JWK212 BJ106MDHT	6.3	X5R	10 μ	±20	10	150	0.85±0.10	
MMRLA219SB5226MTNA01	AWK212 BJ226MDHT	4	X5R	22 μ	±20	10	150	0.85±0.10	

【Temperature Characteristic C6 : X6S(−55~+105°C)】 0.85mm Thickness

New part number	Old part number (for reference)	Rated voltage [V]	Temperature characteristics	Capacitance [F]	Capacitance tolerance [%]	tan δ [%]	HTLT	Thickness*1 [mm]	Note
							Rated voltage x %		
MMRLJ219SC6475□TNA01	JWK212 C6475□DHT	6.3	X6S	4.7 μ	±10, ±20	10	150	0.85±0.10	

Multilayer Ceramic Capacitors

PACKAGING

① Minimum Quantity

● Taped package

Type			Thickness		Standard Quantity [pcs]	
Code	JIS(mm)	EIA(inch)	[mm]	Code	Paper tape	Embossed tape
02	0201	008004	0.125	1	—	50000
04	0402	01005	0.2	2	—	40000
06	0603	0201	0.3	3	15000	—
1L	1005	0402	0.13	H	—	20000
			0.18	E	—	15000
			0.2	2	20000	—
			0.3	3	15000	—
10	1005	0402	0.5	5	10000	—
	0510 ※	0204	0.3	3	10000	—
16	1608	0603	0.45	K	4000	—
			0.7	7		
			0.8	8		
			0.8	8	3000 (Soft Termination)	3000 (Soft Termination)
	0816 ※	0306	0.5	5	—	4000
21	2012	0805	0.85	9	4000	—
			1.25	G	—	3000
			1.25	G	—	2000 (Soft Termination)
	1220 ※	0508	0.85	9	4000	—
31	3216	1206	0.85	9	4000	—
			1.15	Q	—	3000
			1.6	L	—	2000
32	3225	1210	0.85	9	—	2000
			1.15	Q		
			1.9	N		
			2.0 max	Y		
			2.5	M	—	500(T), 1000(P)
45	4532	1812	2.0 max	Y	—	1000
			2.5	M	—	500

注: ※LW Reverse type (MSRL, MCRL, MBRL, MLRL, MMRL)

② Taping material

※ No bottom tape for pressed carrier tape

- Card board carrier tape
- Embossed tape

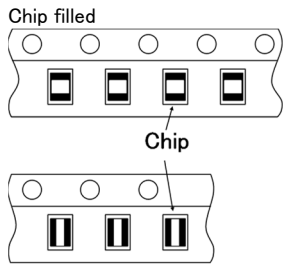
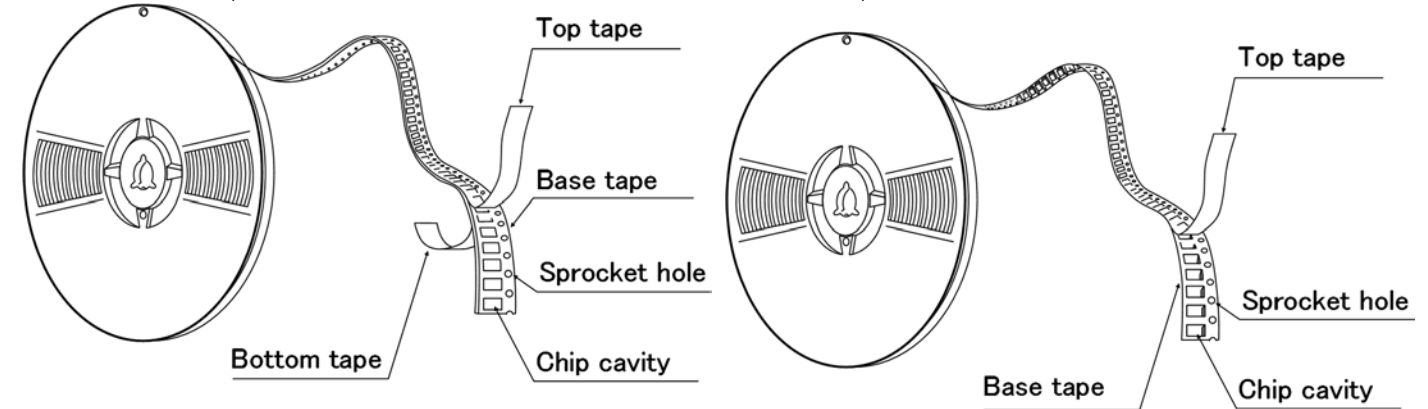

※ LW Reverse type.

③ Representative taping dimensions

● Paper Tape (8mm wide)

● Pressed carrier tape (2mm pitch)

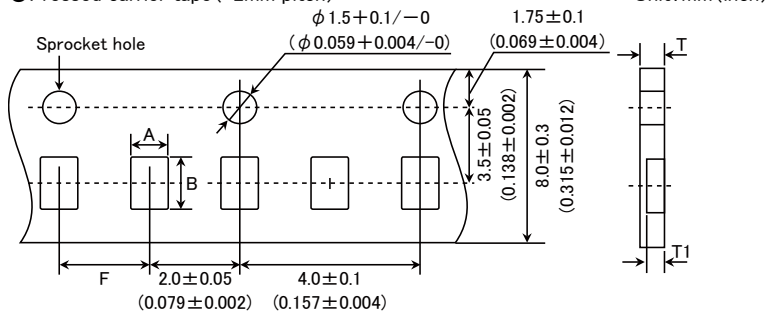

Type(EIA)	Chip Cavity		Insertion Pitch F	Tape Thickness	
	A	B		T	T1
0603 (0201)	0.37	0.67	2.0±0.05	0.45max.	0.42max.
0510 (0204) ※	0.65	1.15		0.4max.	0.3max.
1005 (0402) (*1 2)				0.45max.	0.42max.
1005 (0402) (*1 3)					

Note *1 Thickness, 2:0.2mm, 3:0.3mm. ※ LW Reverse type.

Unit: mm

● Punched carrier tape (2mm pitch)

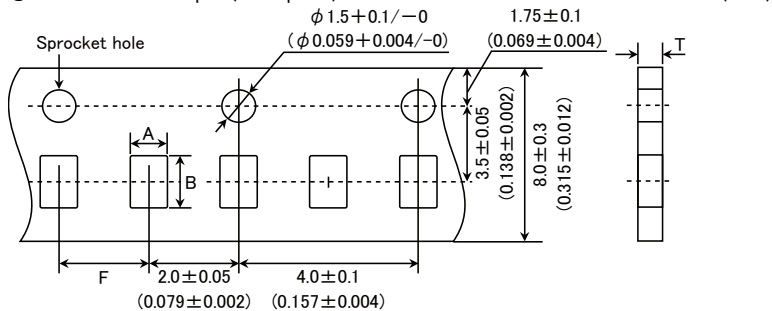

Type(EIA)	Chip Cavity		Insertion Pitch F	Tape Thickness
	A	B		T
1005 (0402)	0.65	1.15	2.0±0.05	0.8max.

Unit: mm

▶ This catalog contains the typical specification only due to the limitation of space. When you consider the purchase of our products, please check our specification. For details of each product (characteristics graph, reliability information, precautions for use, and so on), see our Web site (<http://www.ty-top.com/>).

● Punched carrier tape (4mm pitch)

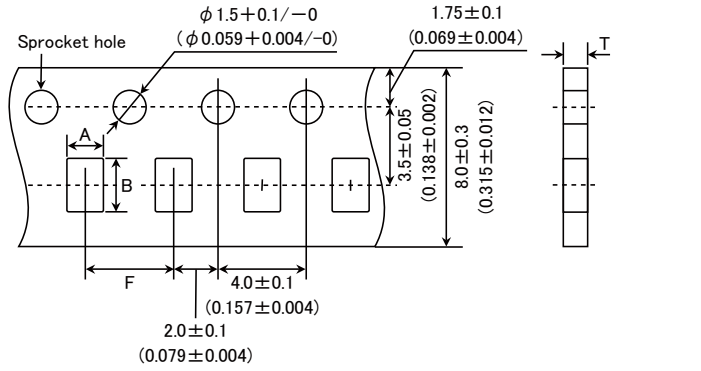

Type(EIA)	Chip Cavity		Insertion Pitch F	Tape Thickness	
	A	B		K	T
1608 (0603)	1.0	1.8	4.0 ± 0.1	1.1max.	
0816 (0306) ※				1.1max.	
2012 (0805)				1.1max.	
1220 (0508) ※	1.65	2.4	4.0 ± 0.1	1.1max.	
3216 (1206)	2.0	3.6		1.1max.	

Note: Taping size might be different depending on the size of the product. ※ LW Reverse type.

Unit: mm

● Embossed tape (4mm wide)

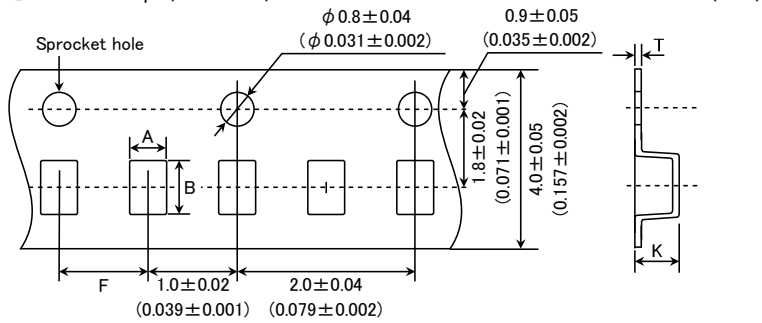

Type(EIA)	Chip Cavity		Insertion Pitch F	Tape Thickness	
	A	B		K	T
0201 (008004)	0.135	0.27	1.0 ± 0.02	0.5max.	0.25max.
0402 (01005)	0.23	0.43			

Unit: mm

● Embossed tape (8mm wide)

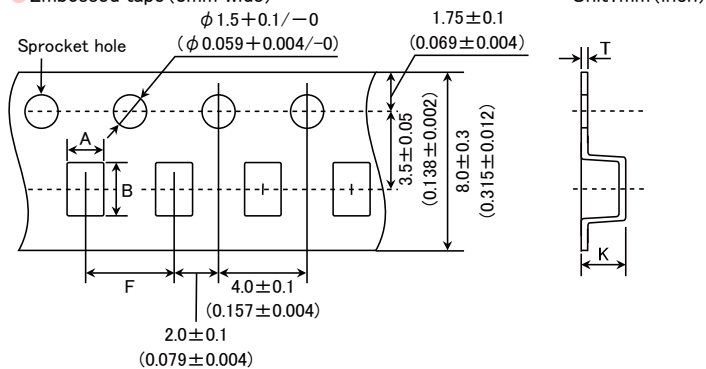

Type(EIA)	Chip Cavity		Insertion Pitch F	Tape Thickness	
	A	B		K	T
1005 (0402)	0.6	1.1	2.0 ± 0.1	0.6max	0.2 ± 0.1
0816 (0306) ※	1.0	1.8	4.0 ± 0.1	1.3max.	0.25 ± 0.1
2012 (0805)	1.65	2.4		3.4max.	0.6max.
3216 (1206)	2.0	3.6			
3225 (1210)	2.8	3.6			

Note: ※ LW Reverse type.

Unit: mm

► This catalog contains the typical specification only due to the limitation of space. When you consider the purchase of our products, please check our specification. For details of each product (characteristics graph, reliability information, precautions for use, and so on), see our Web site (<http://www.ty-top.com/>).

● Embossed tape (12mm wide) Unit: mm (inch)

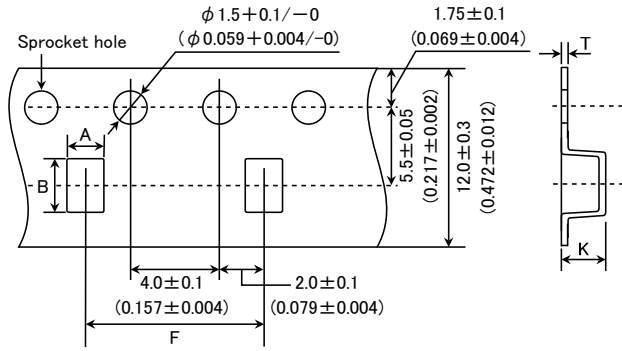

Type(EIA)	Chip Cavity		Insertion Pitch	Tape Thickness	
	A	B		K	T
3225 (1210)	3.1	4.0	8.0 ± 0.1	4.0max.	0.6max.
4532 (1812)	3.7	4.9	8.0 ± 0.1	4.0max.	0.6max.

Unit: mm

④ Trailer and Leader

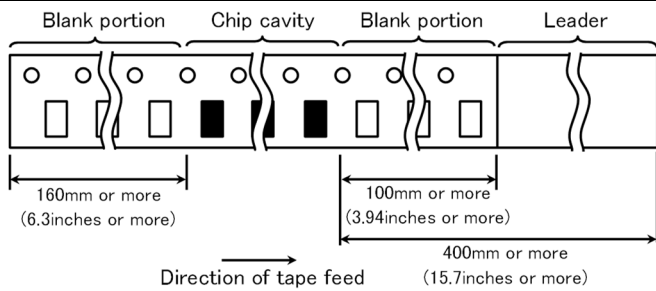

⑤ Reel size

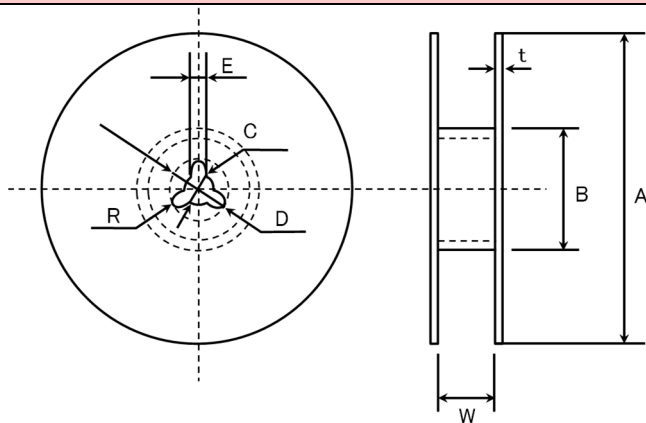

A	B	C	D	E	R
$\phi 178 \pm 2.0$	$\phi 50 \text{min.}$	$\phi 13.0 \pm 0.2$	$\phi 21.0 \pm 0.8$	2.0 ± 0.5	1.0

	T	W
4mm wide tape	1.5max.	5 ± 1.0
8mm wide tape	2.5max.	10 ± 1.5
12mm wide tape	2.5max.	14 ± 1.5

Unit: mm

⑥ Top Tape Strength

The top tape requires a peel-off force of 0.1 to 0.7N in the direction of the arrow as illustrated below.

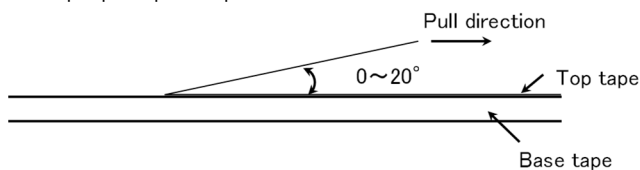

▶ This catalog contains the typical specification only due to the limitation of space. When you consider the purchase of our products, please check our specification. For details of each product (characteristics graph, reliability information, precautions for use, and so on), see our Web site (<http://www.ty-top.com/>).

Multilayer Ceramic Capacitors for Telecommunications Infrastructure and Industrial Equipment

Multilayer Ceramic Capacitors for Medical Devices classified as GHTF Class C (Japan Class III)

RELIABILITY DATA

1. Operating Temperature Range

Specified Value	Temperature Compensating(Class1)	-55 to +125°C		
	High Permittivity (Class2)		Specification	Temperature Range
		B5	X5R	-55 to +85°C
		B7	X7R	-55 to +125°C
		C6	X6S	-55 to +105°C
		C7	X7S	-55 to +125°C
D7	X7T	-55 to +125°C		

2. Storage Conditions

Specified Value	Temperature Compensating(Class1)	-55 to +125°C		
	High Permittivity (Class2)		Specification	Temperature Range
		B5	X5R	-55 to +85°C
		B7	X7R	-55 to +125°C
		C6	X6S	-55 to +105°C
		C7	X7S	-55 to +125°C
D7	X7T	-55 to +125°C		

3. Rated Voltage

Specified Value	Temperature Compensating(Class1)	50VDC, 25VDC
	High Permittivity (Class2)	50VDC, 35VDC, 25VDC, 16VDC, 10VDC, 6.3VDC, 4VDC

4. Withstanding Voltage (Between terminals)

Specified Value	Temperature Compensating(Class1)	No breakdown or damage	
	High Permittivity (Class2)		
Test Methods and Remarks		Class 1	Class 2
	Applied voltage	Rated volta × 3	Rated voltage × 2.5
	Duration	1 to 5 sec.	
	Charge/discharge current	50mA max.	

5. Insulation Resistance

Specified Value	Temperature Compensating(Class1)	10000 MΩ min.
	High Permittivity (Class2) Note 1	$C \leq 0.047 \mu F$: 10000 MΩ min. $C > 0.047 \mu F$: $500M\Omega \cdot \mu F$ (C:Nominal capacitance)
Test Methods and Remarks	Applied voltage	: Rated voltage
	Duration	: 60±5 sec.
	Charge/discharge current	: 50mA max.

6. Capacitance (Tolerance)

Specified Value	Temperature Compensating(Class1)	$C \leq 5pF$: ±0.25pF $5pF < C \leq 10pF$: ±0.5pF $C > 10pF$: ±5% (C:Nominal capacitance)		
	High Permittivity (Class2)	±10% or ±20%		
Test Methods and Remarks		Class 1	Class 2	
	Preconditioning	None	$C \leq 10 \mu F$	$C > 10 \mu F$
	Measuring frequency	1MHz±10%	Thermal treatment (at 150°C for 1hr) Note 2	
	Measuring voltage Note 1	0.5 to 5Vrms	1±0.2Vrms	120±10Hz
	Bias application	None		

► This catalog contains the typical specification only due to the limitation of space. When you consider the purchase of our products, please check our specification. For details of each product (characteristics graph, reliability information, precautions for use, and so on), see our Web site (<http://www.ty-top.com/>).

7. Q or Dissipation Factor

Specified Value	Temperature Compensating (Class1)	C < 30pF : Q ≥ 400 + 20C C ≥ 30pF : Q ≥ 1000 (C: Nominal capacitance)	
	High Permittivity (Class2) Note 1	2.5% max.	
Test Methods and Remarks		Class 1	Class 2
			C ≤ 10 μF C > 10 μF
	Preconditioning	None	Thermal treatment (at 150°C for 1hr) Note 2
	Measuring frequency	1MHz ± 10%	1kHz ± 10% 120 ± 10Hz
	Measuring voltage Note 1	0.5 to 5Vrms	1 ± 0.2Vrms 0.5 ± 0.1Vrms
Bias application	None		

8. Temperature Characteristic (Without voltage application)

Specified Value	Temperature Compensating (Class1)	Temperature Characteristic [ppm/°C]		Tolerance [ppm/°C]		
		C□: 0	CG, CH, CJ, CK	G : ±30	H : ±60	
High Permittivity (Class2)			Specification	Capacitance change	Reference temperature	Temperature Range
	B5	X5R		±15%	25°C	-55 to +85°C
	B7	X7R		±15%	25°C	-55 to +125°C
	C6	X6S		±22%	25°C	-55 to +105°C
	C7	X7S		±22%	25°C	-55 to +125°C
	D7	X7T		+22/-33%	25°C	-55 to +125°C

Class 1 : Capacitance at 20°C and 85°C shall be measured in thermal equilibrium, and the temperature characteristic shall be calculated from the following equation.

$$\frac{(C_{85} - C_{20})}{C_{20} \times \Delta T} \times 10^6 (\text{ppm}/^\circ\text{C}) \quad \Delta T = 65$$

Class 2 : Capacitance at each step shall be measured in thermal equilibrium, and the temperature characteristic shall be calculated from the following equation.

Step	Temperature
1	Minimum operating temperature
2	25°C
3	Maximum operating temperature

$$\frac{(C - C_2)}{C_2} \times 100 (\%)$$

C : Capacitance in Step 1 or Step 3
C2 : Capacitance in Step 2
※Measuring Frequency, Measuring Voltage: Refer to detailed specification

9. Deflection

Specified Value	Temperature Compensating (Class1)	Appearance : No abnormality Capacitance change : Within ±5% or ±0.5 pF, whichever is larger.
	High Permittivity (Class2)	Appearance : No abnormality Capacitance change : Within ±12.5%

Test Methods and Remarks	Multilayer Ceramic Capacitors	
	0603, ※11005 Type	The other types
	Glass epoxy-resin substrate	
	Board	0.8mm 1.6mm
	Warp	1mm (Soft Termination type:3mm)
Duration	10 sec.	

※1: 1005 Type thickness, ,3: 0.3mm.

(Unit: mm)
Capacitance measurement shall be conducted with the board bent

▶ This catalog contains the typical specification only due to the limitation of space. When you consider the purchase of our products, please check our specification. For details of each product (characteristics graph, reliability information, precautions for use, and so on), see our Web site (<http://www.ty-top.com/>).

10. Adhesive Strength of Terminal Electrodes

Specified Value	Temperature Compensating(Class1)	No terminal separation or its indication.	
	High Permittivity (Class2)		
Test Methods and Remarks		0603 Type	1005 Type or more
	Applied force	2N	5N
	Duration	10±1 sec.	30±5 sec. (Soft Termination type: 10±1 sec.)

11. Vibration

Specified Value	Temperature Compensating(Class1)	Initial performance shall be satisfied.
	High Permittivity (Class2)	
Test Methods and Remarks	Preconditioning	: Thermal treatment(at 150°C for 1hr) Note2 (Only High permittivity)
	Frequency range	: 10 to 55 Hz
	Overall amplitude	: 1.5 mm
	Sweeping method	: 10 to 55 to 10 Hz for 1 min
		Two hours each in X, Y, Z directions: 6 hrs in total

12. Solderability

Specified Value	Temperature Compensating(Class1)	At least 95% of terminal electrode is covered by new solder.	
	High Permittivity (Class2)		
Test Methods and Remarks		Eutectic solder	Lead-free solder
	Solder type	H60A or H63A	Sn-3.0Ag-0.5Cu
	Solder temperature	230±5°C	245±3°C
	Duration	4±1 sec.	

13. Resistance to Soldering

Specified Value	Temperature Compensating(Class1)	Appearance	: No abnormality	
		Capacitance change	: Within ±2.5% or ±0.25pF, whichever is larger.	
Specified Value	High Permittivity (Class2) Note 1	Q	: Initial value	
		Insulation resistance	: Initial value	
Specified Value	High Permittivity (Class2) Note 1	Withstanding voltage (between terminals)	: No abnormality	
		Appearance	: No abnormality	
Specified Value	High Permittivity (Class2) Note 1	Capacitance change	: Within ±7.5%	
		Dissipation factor	: Initial value	
Specified Value	High Permittivity (Class2) Note 1	Insulation resistance	: Initial value	
		Withstanding voltage (between terminals)	: No abnormality	
Test Methods and Remarks		Class 1		
		0603 Type	1005 Type	
	Preconditioning	None		
	Preheating	150°C, 1 to 2 min.	80 to 100°C, 2 to 5 min. 150 to 200°C, 2 to 5 min.	
	Solder temp.	270±5°C		
	Duration	3±0.5 sec.		
	Recovery	24±2hrs (Standard condition) Note 5		
		Class 2		
		0603 Type	1005, 1608, 2012 Type	3216, 3225 Type
	Preconditioning	Thermal treatment (at 150°C for 1 hr) Note 2		
	Preheating	150°C, 1 to 2 min.	80 to 100°C, 2 to 5 min. 150 to 200°C, 2 to 5 min.	80 to 100°C, 5 to 10 min. 150 to 200°C, 5 to 10 min.
	Solder temp.	270±5°C		
	Duration	3±0.5 sec.		
	Recovery	24±2 hrs (Standard condition) Note 5		

► This catalog contains the typical specification only due to the limitation of space. When you consider the purchase of our products, please check our specification. For details of each product (characteristics graph, reliability information, precautions for use, and so on), see our Web site (<http://www.ty-top.com/>).

14. Temperature Cycle (Thermal Shock)

Specified Value	Temperature Compensating(Class1)	Appearance : No abnormality Capacitance change : Within $\pm 2.5\%$ or $\pm 0.25\text{pF}$, whichever is larger. Q : Initial value Insulation resistance : Initial value Withstanding voltage (between terminals) : No abnormality																
	High Permittivity (Class2) Note 1	Appearance : No abnormality Capacitance change : Within $\pm 7.5\%$ Dissipation factor : Initial value Insulation resistance : Initial value Withstanding voltage (between terminals) : No abnormality																
Test Methods and Remarks	Class 1	Class 2																
	Preconditioning	None	Thermal treatment (at 150°C for 1 hr) Note 2															
	1 cycle	<table border="1" style="width: 100%; border-collapse: collapse; text-align: center;"> <thead> <tr> <th style="width: 5%;">Step</th> <th style="width: 60%;">Temperature (°C)</th> <th style="width: 35%;">Time (min.)</th> </tr> </thead> <tbody> <tr> <td>1</td> <td>Minimum operating temperature</td> <td>30±3</td> </tr> <tr> <td>2</td> <td>Normal temperature</td> <td>2 to 3</td> </tr> <tr> <td>3</td> <td>Maximum operating temperature</td> <td>30±3</td> </tr> <tr> <td>4</td> <td>Normal temperature</td> <td>2 to 3</td> </tr> </tbody> </table>		Step	Temperature (°C)	Time (min.)	1	Minimum operating temperature	30±3	2	Normal temperature	2 to 3	3	Maximum operating temperature	30±3	4	Normal temperature	2 to 3
	Step	Temperature (°C)	Time (min.)															
	1	Minimum operating temperature	30±3															
2	Normal temperature	2 to 3																
3	Maximum operating temperature	30±3																
4	Normal temperature	2 to 3																
Number of cycles	50 times																	
Recovery	24±2hrs (Standard condition) Note 5	24±2 hrs (Standard condition) Note 5																

15. Humidity (Steady State)

Specified Value	Temperature Compensating(Class1)	Appearance : No abnormality Capacitance change : Within $\pm 5\%$ or $\pm 0.5\text{pF}$, whichever is larger. Q : $C < 10\text{pF} : Q \geq 200 + 10C$ $10 \leq C < 30\text{pF} : Q \geq 275 + 2.5C$ $C \geq 30\text{pF} : Q \geq 350$ (C:Nominal capacitance) Insulation resistance : 1000 MΩ min.
	High Permittivity (Class2) Note 1	Appearance : No abnormality Capacitance change : Within $\pm 12.5\%$ Dissipation factor : 5.0% max. Insulation resistance : 50 MΩ μF or 1000 MΩ whichever is smaller.
Test Methods and Remarks	Preconditioning : Thermal treatment (at 150°C for 1 hr) Note 2 (Only High permittivity) Temperature : 40±2°C Humidity : 90 to 95%RH Duration : 500+24/-0 hrs Recovery : 24±2 hrs (Standard condition) Note 1,5	

16. Humidity Loading

Specified Value	Temperature Compensating(Class1)	Appearance : No abnormality Capacitance change : Within $\pm 7.5\%$ or $\pm 0.75\text{pF}$, whichever is larger. Q : $C < 30\text{pF} : Q \geq 100 + 10C/3$ $C \geq 30\text{pF} : Q \geq 200$ (C:Nominal capacitance) Insulation resistance : 500 MΩ min.
	High Permittivity (Class2) Note 1	Appearance : No abnormality Capacitance change : Within $\pm 12.5\%$ Dissipation factor : 5.0% max. Insulation resistance : 25 MΩ μF or 500 MΩ, whichever is smaller.
Test Methods and Remarks	Preconditioning : Voltage treatment (Rated voltage are applied for 1 hour at 40°C) Note 1,3 (Only High permittivity) Temperature : 60±2°C Humidity : 90 to 95%RH Duration : 500+24/-0 hrs Applied voltage : Rated voltage Charge/discharge current : 50mA max. Recovery : 24±2 hrs (Standard condition) Note 1,5	

► This catalog contains the typical specification only due to the limitation of space. When you consider the purchase of our products, please check our specification.
 For details of each product (characteristics graph, reliability information, precautions for use, and so on), see our Web site (<http://www.ty-top.com/>).

17. High Temperature Loading

Specified Value	Temperature Compensating(Class1)	Appearance : No abnormality Capacitance change : Within $\pm 3\%$ or $\pm 0.3\text{pF}$, whichever is larger. Q : $C < 10\text{pF}$: $Q \geq 200 + 10C$ $10 \leq C < 30\text{pF}$: $Q \geq 275 + 2.5C$ $C \geq 30\text{pF}$: $Q \geq 350$ (C:Nominal capacitance) Insulation resistance : 1000 M Ω min.
	High Permittivity (Class2) Note 1	Appearance : No abnormality Capacitance change : Within $\pm 12.5\%$ Dissipation factor : 5.0% max. Insulation resistance : 50 M Ω μF or 1000 M Ω , whichever is smaller.
Test Methods and Remarks	Preconditioning :Voltage treatment (Twice the rated voltage shall be applied for 1 hour at 85°C, 105°C or 125°C) Note 1,3,4 (Only High permittivity) Temperature :Maximum operating temperature Duration :1000+24/-0 hrs Applied voltage : Rated voltage $\times 2$ Note 4 Charge/discharge current : 50mA max. Recovery : 24 \pm 2 hrs (Standard condition) Note 1,5	

Note 1 The figures indicate typical specifications. Please refer to individual specifications in detail.

Note 2 Thermal treatment : Initial value shall be measured after test sample is heat-treated at 150+0/-10°C for an hour and kept at room temperature for 24 \pm 2hours.

Note 3 Voltage treatment : Initial value shall be measured after test sample is voltage-treated for an hour at both the temperature and voltage specified in the test conditions, and kept at room temperature for 24 \pm 2hours.

Note 4 150% of rated voltage is applicable to some items. Please refer to their specifications for further information.

Note 5 Standard condition: Temperature: 5 to 35°C, Relative humidity: 45 to 85 % RH, Air pressure: 86 to 106kPa When there are questions concerning measurement results, in order to provide correlation data, the test shall be conducted under the following condition.

Temperature: 20 \pm 2°C, Relative humidity: 60 to 70 % RH, Air pressure: 86 to 106kPa Unless otherwise specified, all the tests are conducted under the "standard condition".

**Medium-High Voltage Multilayer Ceramic Capacitor
for Telecommunications Infrastructure and Industrial Equipment**
**High frequency/Low loss Medium-High Voltage Multilayer Ceramic Capacitor
for Telecommunications Infrastructure and Industrial Equipment**
**Medium-High Voltage Multilayer Ceramic Capacitor
for Medical Devices classified as GHTF Class C (Japan Class III)**
**High frequency/Low loss Medium-High Voltage Multilayer Ceramic Capacitor
for Medical Devices classified as GHTF Class C (Japan Class III)**

■ RELIABILITY DATA

1. Operating Temperature Range	
Specified Value	Temperature Compensating (High Frequency type) CG(C0G) : -55 to +125°C High permittivity X7R, X7S : -55 to +125°C
2. Storage Temperature Range	
Specified Value	Temperature Compensating (High Frequency type) CG(C0G) : -55 to +125°C High permittivity X7R, X7S : -55 to +125°C
3. Rated Voltage	
Specified Value	100VDC(Code:H), 250VDC(Code:Q), 630VDC(Code:S)
4. Withstanding Voltage (Between terminals)	
Specified Value	No breakdown or damage
Test Methods and Remarks	Applied voltage : Rated voltage (H) × 2.5, Rated voltage (Q) × 2, Rated voltage (S) × 1.2 Duration : 1 to 5sec. Charge/discharge current : 50mA max.
5. Insulation Resistance	
Specified Value	Temperature Compensating (High Frequency type) 10000MΩ min High permittivity 100MΩ μF or 10GΩ, whichever is smaller.
Test Methods and Remarks	Applied voltage : Rated voltage (H, Q), 500V (S) Duration : 60±5sec. Charge/discharge current : 50mA max.

6. Capacitance (Tolerance)

Specified Value	Temperature Compensating (High Frequency type) $C < 0.5\text{pF}$ ($\pm 0.05\text{pF}$ or $\pm 0.1\text{pF}$), $0.5\text{pF} \leq C < 5\text{pF}$ ($\pm 0.1\text{pF}$ or $\pm 0.25\text{pF}$) $5\text{pF} \leq C < 10$ ($\pm 0.25\text{pF}$ or $\pm 0.5\text{pF}$) $C \geq 10\text{pF}$ ($\pm 5\%$) (C: Nominal capacitance)
Test Methods and Remarks	High permittivity $\pm 10\%$, $\pm 20\%$
Test Methods and Remarks	Temperature Compensating (High Frequency type) Measuring frequency : $1\text{MHz} \pm 10\%$ Measuring voltage : 0.5 to 5Vrms Bias application : None
Test Methods and Remarks	High permittivity Measuring frequency : $1\text{kHz} \pm 10\%$ Measuring voltage : $1 \pm 0.2\text{Vrms}$ Bias application : None

7. Q or Dissipation Factor

Specified Value	Temperature Compensating (High Frequency type) $C < 30\text{pF}$: $Q \geq 800 + 20C$ $C \geq 30\text{pF}$: $Q \geq 1400$ (C: Normal Capacitance)
Test Methods and Remarks	High permittivity $3.5\% \text{max (H)}$ $2.5\% \text{max (Q, S)}$
Test Methods and Remarks	Temperature Compensating (High Frequency type) Measuring frequency : $1\text{MHz} \pm 10\%$ Measuring voltage : 0.5 to 5Vrms Bas application : None
Test Methods and Remarks	High permittivity Measuring frequency : $1\text{kHz} \pm 10\%$ Measuring voltage : $1 \pm 0.2\text{Vrms}$ Bas application : None

8. Temperature Characteristic of Capacitance

Specified Value	Temperature Compensating (High Frequency type) CG(C0G) : $0 \pm 30\text{ppm} (-55 \text{ to } +125^\circ\text{C})$								
Test Methods and Remarks	High permittivity X7R : $\pm 15\% (-55 \text{ to } +125^\circ\text{C})$ X7S : $\pm 22\% (-55 \text{ to } +125^\circ\text{C})$								
Test Methods and Remarks	Temperature Compensating (High Frequency type) Capacitance at 25°C and 85°C shall be measured in thermal equilibrium, and the temperature characteristic shall be calculated from the following equation. $\frac{(C_{85} - C_{25})}{C_{25} \times \Delta T} \times 10^6 \times [\text{ppm}/^\circ\text{C}]$								
Test Methods and Remarks	High permittivity Capacitance value at each step shall be measured in thermal equilibrium, and the temperature characteristic shall be calculated from the following equation. <table border="1" style="margin: 10px auto; border-collapse: collapse; text-align: center;"> <thead> <tr> <th style="padding: 2px;">Step</th> <th style="padding: 2px;">Temperature</th> </tr> </thead> <tbody> <tr> <td style="padding: 2px;">1</td> <td style="padding: 2px;">Minimum operating temperature</td> </tr> <tr> <td style="padding: 2px;">2</td> <td style="padding: 2px;">25°C</td> </tr> <tr> <td style="padding: 2px;">3</td> <td style="padding: 2px;">Maximum operating temperature</td> </tr> </tbody> </table> $\frac{(C - C_2)}{C_2} \times 100(\%)$ <p>C : Capacitance value in Step 1 or Step 3 C2 : Capacitance value in Step 2</p>	Step	Temperature	1	Minimum operating temperature	2	25°C	3	Maximum operating temperature
Step	Temperature								
1	Minimum operating temperature								
2	25°C								
3	Maximum operating temperature								

► This catalog contains the typical specification only due to the limitation of space. When you consider the purchase of our products, please check our specification. For details of each product (characteristics graph, reliability information, precautions for use, and so on), see our Web site (<http://www.ty-top.com/>).

9. Deflection

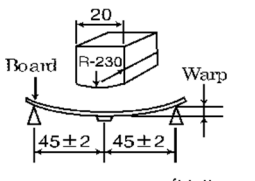
Specified Value	Temperature Compensating (High Frequency type) Appearance : No abnormality Capacitance change : $\pm 5\%$ or $\pm 0.5\text{pF}$, whichever is larger.
	High permittivity Appearance : No abnormality Capacitance change : Within $\pm 10\%$
Test Methods and Remarks	Warp : 1mm (Soft Termination type:3mm) Duration : 10sec. Test board : Glass epoxy-resin substrate Thickness : 1.6mm
	 <p>(Unit: mm)</p> <p>Capacitance measurement shall be conducted with the board bent.</p>

10. Adhesive Strength of Terminal Electrodes

Specified Value	No terminal separation or its indication.
Test Methods and Remarks	Applied force : 5N
	Duration : $30 \pm 5\text{sec}$. (Soft Termination type: $10 \pm 1\text{sec}$)

11. Vibration

Specified Value	Initial performance shall be satisfied.
Test Methods and Remarks	Preconditioning : Thermal treatment (at 150°C for 1hr) Note1 (Only High permittivity)
	Frequency range : 10 to 55 Hz Overall amplitude : 1.5 mm Sweeping method : 10 to 55 to 10 Hz for 1 min Two hours each in X, Y, Z directions: 6 hrs in total

12. Solderability

Specified Value	At least 95% of terminal electrode is covered by new solder		
Test Methods and Remarks		Eutectic solder	Lead-free solder
	Solder type	H60A or H63A	Sn-3.0Ag-0.5Cu
	Solder temperature	$230 \pm 5^\circ\text{C}$	$245 \pm 3^\circ\text{C}$
	Duration	$4 \pm 1\text{ sec}$.	

13. Resistance to Soldering

Specified Value	Temperature Compensating (High Frequency type) Appearance : No abnormality Capacitance change : Within $\pm 2.5\%$ or $\pm 0.25\text{pF}$, whichever is larger. Insulation resistance : Initial value Withstanding voltage (between terminals) : No abnormality
	High permittivity Appearance : No abnormality Capacitance change : Within $\pm 15\%$ (H), $\pm 10\%$ (Q, S) Dissipation factor : Initial value Insulation resistance : Initial value Withstanding voltage (between terminals) : No abnormality
Test Methods and Remarks	Preconditioning : Thermal treatment (at 150°C for 1hr) Note1 (Only High permittivity)
	Solder temperature : $270 \pm 5^\circ\text{C}$ Duration : $3 \pm 0.5\text{sec}$. Preheating conditions : 80 to 100°C , 2 to 5 min. 150 to 200°C , 2 to 5 min. Recovery : $24 \pm 2\text{hrs}$ under the standard condition Note3

14. Temperature Cycle (Thermal Shock)

Specified Value	Temperature Compensating (High Frequency type)														
	Appearance : No abnormality Capacitance change : Within $\pm 2.5\%$ or $\pm 0.25\text{pF}$, whichever is larger. Insulation resistance : Initial value Withstanding voltage (between terminals) : No abnormality														
Specified Value	High permittivity														
	Appearance : No abnormality Capacitance change : Within $\pm 15\%$ (H), $\pm 7.5\%$ (Q, S) Dissipation factor : Initial value Insulation resistance : Initial value Withstanding voltage (between terminals) : No abnormality														
Test Methods and Remarks	Preconditioning : Thermal treatment (at 150°C for 1hr) Note1 Conditions for 1 cycle														
	<table border="1"> <thead> <tr> <th>Step</th> <th>temperature ($^{\circ}\text{C}$)</th> <th>Time (min.)</th> </tr> </thead> <tbody> <tr> <td>1</td> <td>Minimum operating temperature</td> <td>30 ± 3min.</td> </tr> <tr> <td>2</td> <td>Normal temperature</td> <td>2 to 3min.</td> </tr> <tr> <td>3</td> <td>Maximum operating temperature</td> <td>30 ± 3min.</td> </tr> <tr> <td>4</td> <td>Normal temperature</td> <td>2 to 3min.</td> </tr> </tbody> </table> Number of cycles : 50 times Recovery : 24 ± 2 hrs under the standard condition Note3	Step	temperature ($^{\circ}\text{C}$)	Time (min.)	1	Minimum operating temperature	30 ± 3 min.	2	Normal temperature	2 to 3min.	3	Maximum operating temperature	30 ± 3 min.	4	Normal temperature
Step	temperature ($^{\circ}\text{C}$)	Time (min.)													
1	Minimum operating temperature	30 ± 3 min.													
2	Normal temperature	2 to 3min.													
3	Maximum operating temperature	30 ± 3 min.													
4	Normal temperature	2 to 3min.													

15. Humidity (Steady state)

Specified Value	Temperature Compensating (High Frequency type)
	Appearance : No abnormality Capacitance change : Within $\pm 5\%$ or $\pm 0.5\text{pF}$, whichever is larger. Insulation resistance : $1000\text{M}\Omega$ min
Specified Value	High permittivity
	Appearance : No abnormality Capacitance change : Within $\pm 15\%$ Dissipation factor : $7\%\text{max}$ (H), $5\%\text{max}$ (Q, S). Insulation resistance : $25\text{M}\Omega$ μF or $1000\text{M}\Omega$, whichever is smaller.
Test Methods and Remarks	Preconditioning : Thermal treatment (at 150°C for 1hr) Note1 (Only High permittivity)
	Temperature : $40 \pm 2^{\circ}\text{C}$ Humidity : 90 to 95%RH Duration : 500 +24/-0 hrs Recovery : 24 ± 2 hrs under the standard condition Note3

16. Humidity Loading

Specified Value	Temperature Compensating (High Frequency type)
	Appearance : No abnormality Capacitance change : $C \leq 2.0\text{pF} : \pm 0.4\text{pF}$ $2.0\text{pF} < C < 10\text{pF} : \pm 0.75\text{pF}$ $C \geq 10\text{pF} : \pm 7.5\%$ (C: Nominal capacitance) Insulation resistance : $500\text{M}\Omega$ min
Specified Value	High permittivity
	Appearance : No abnormality Capacitance change : Within $\pm 15\%$ Dissipation factor : $7\%\text{max}$ (H), $5\%\text{max}$ (Q, S). Insulation resistance : $10\text{M}\Omega$ μF or $500\text{M}\Omega$, whichever is smaller.
Test Methods and Remarks	Preconditioning : Voltage treatment Note2 (Only High permittivity)
	Temperature : $60 \pm 2^{\circ}\text{C}$ Humidity : 90 to 95%RH Duration : 500 +24/-0 hrs Applied voltage : Rated voltage Charge/discharge current : 50mA max. Recovery : 24 ± 2 hrs under the standard condition Note3

► This catalog contains the typical specification only due to the limitation of space. When you consider the purchase of our products, please check our specification. For details of each product (characteristics graph, reliability information, precautions for use, and so on), see our Web site (<http://www.ty-top.com/>).

Multilayer Ceramic Capacitors

PRECAUTIONS

1. Circuit Design

- Precautions**
- ◆ Verification of operating environment, electrical rating and performance
 1. A malfunction of equipment in fields such as medical, aerospace, nuclear control, etc. may cause serious harm to human life or have severe social ramifications. Therefore, any capacitors to be used in such equipment may require higher safety and reliability, and shall be clearly differentiated from them used in general purpose applications.
 - ◆ Operating Voltage (Verification of Rated voltage)
 1. The operating voltage for capacitors must always be their rated voltage or less.
 - If an AC voltage is loaded on a DC voltage, the sum of the two peak voltages shall be the rated voltage or less.
 - For a circuit where an AC or a pulse voltage may be used, the sum of their peak voltages shall also be the rated voltage or less.
 2. Even if an applied voltage is the rated voltage or less reliability of capacitors may be deteriorated in case that either a high frequency AC voltage or a pulse voltage having rapid rise time is used in a circuit.

2. PCB Design

- Precautions**
- ◆ Pattern configurations (Design of Land-patterns)
 1. When capacitors are mounted on PCBs, the amount of solder used (size of fillet) can directly affect the capacitor performance. Therefore, the following items must be carefully considered in the design of land patterns:
 - (1) Excessive solder applied can cause mechanical stresses which lead to chip breaking or cracking. Therefore, please consider appropriate land-patterns for proper amount of solder.
 - (2) When more than one component are jointly soldered onto the same land, each component's soldering point shall be separated by solder-resist.
 - ◆ Pattern configurations (Capacitor layout on PCBs)

After capacitors are mounted on boards, they can be subjected to mechanical stresses in subsequent manufacturing processes (PCB cutting, board inspection, mounting of additional parts, assembly into the chassis, wave soldering of the boards, etc.). For this reason, land pattern configurations and positions of capacitors shall be carefully considered to minimize stresses.

Technical considerations

- ◆ Pattern configurations (Design of Land-patterns)

The following diagrams and tables show some examples of recommended land patterns to prevent excessive solder amounts.

(1) Recommended land dimensions for typical chip capacitors

 - Multilayer Ceramic Capacitors : Recommended land dimensions (unit: mm)

Wave-soldering

Type	1608	2012	3216	3225	
Size	L	1.6	2.0	3.2	3.2
	W	0.8	1.25	1.6	2.5
A	0.8 to 1.0	1.0 to 1.4	1.8 to 2.5	1.8 to 2.5	
B	0.5 to 0.8	0.8 to 1.5	0.8 to 1.7	0.8 to 1.7	
C	0.6 to 0.8	0.9 to 1.2	1.2 to 1.6	1.8 to 2.5	

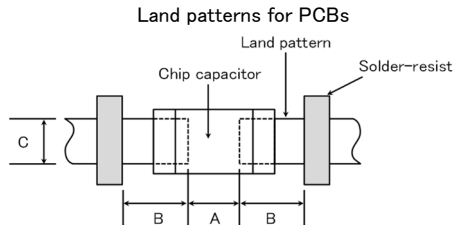

Reflow-soldering

Type	0201	0402	0603	1005	1608	2012	3216	3225	4532
Size	L	0.25	0.4	0.6	1.0	1.6	2.0	3.2	4.5
	W	0.125	0.2	0.3	0.5	0.8	1.25	1.6	3.2
A	0.095~0.135	0.15~0.25	0.20~0.30	0.45~0.55	0.6~0.8	0.8~1.2	1.8~2.5	1.8~2.5	2.5~3.5
B	0.085~0.125	0.10~0.20	0.20~0.30	0.40~0.50	0.6~0.8	0.8~1.2	1.0~1.5	1.0~1.5	1.5~1.8
C	0.110~0.150	0.15~0.30	0.25~0.40	0.45~0.55	0.6~0.8	0.9~1.6	1.2~2.0	1.8~3.2	2.3~3.5

Note: Recommended land size might be different according to the allowance of the size of the product.

 - LWDC: Recommended land dimensions for reflow-soldering (unit: mm)

Type	0510	0816	1220	
Size	L	0.52	0.8	1.25
	W	1.0	1.6	2.0
A	0.18~0.22	0.25~0.3	0.5~0.7	
B	0.2~0.25	0.3~0.4	0.4~0.5	
C	0.9~1.1	1.5~1.7	1.9~2.1	

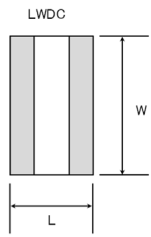

▶ This catalog contains the typical specification only due to the limitation of space. When you consider the purchase of our products, please check our specification. For details of each product (characteristics graph, reliability information, precautions for use, and so on), see our Web site (<http://www.ty-top.com/>).

(2) Examples of good and bad solder application

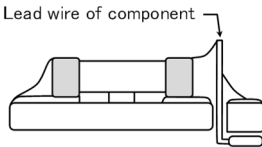
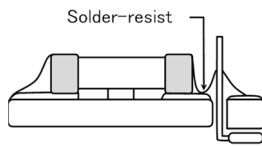
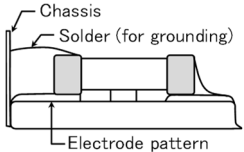
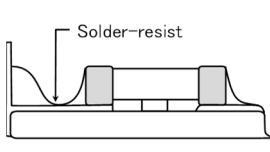
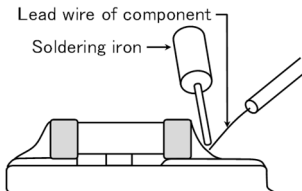
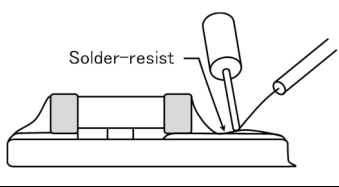
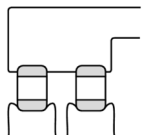
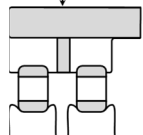
Item	Not recommended	Recommended
Mixed mounting of SMD and leaded components		
Component placement close to the chassis		
Hand-soldering of leaded components near mounted components		
Horizontal component placement		

◆ Pattern configurations (Capacitor layout on PCBs)

1-1. The following is examples of good and bad capacitor layouts ; capacitors shall be located to minimize any possible mechanical stresses from board warp or deflection.

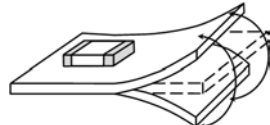
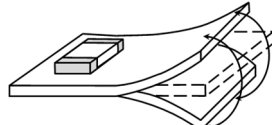
Items	Not recommended	Recommended
Deflection of board		

Place the product at a right angle to the direction of the anticipated mechanical stress.

1-2. The amount of mechanical stresses given will vary depending on capacitor layout. Please refer to diagram below.

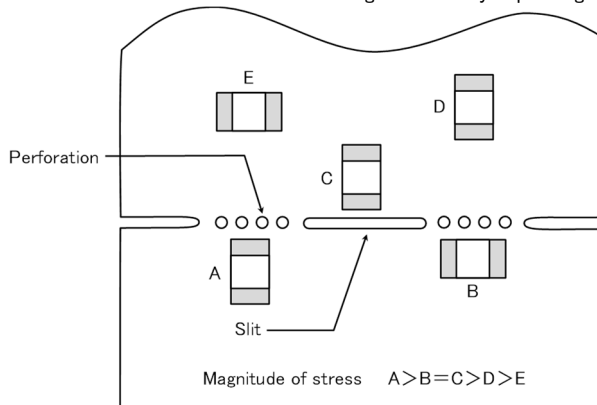

1-3. When PCB is split, the amount of mechanical stress on the capacitors can vary according to the method used. The following methods are listed in order from least stressful to most stressful: push-back, slit, V-grooving, and perforation. Thus, please consider the PCB, split methods as well as chip location.

3. Mounting

Precautions

◆ Adjustment of mounting machine

- When capacitors are mounted on PCB, excessive impact load shall not be imposed on them.
- Maintenance and inspection of mounting machines shall be conducted periodically.

◆ Selection of Adhesives

- When chips are attached on PCBs with adhesives prior to soldering, it may cause capacitor characteristics degradation unless the following factors are appropriately checked : size of land patterns, type of adhesive, amount applied, hardening temperature and hardening period. Therefore, please contact us for further information.

◆ Adjustment of mounting machine

1. When the bottom dead center of a pick-up nozzle is too low, excessive force is imposed on capacitors and causes damages. To avoid this, the following points shall be considerable.
 - (1) The bottom dead center of the pick-up nozzle shall be adjusted to the surface level of PCB without the board deflection.
 - (2) The pressure of nozzle shall be adjusted between 1 and 3 N static loads.
 - (3) To reduce the amount of deflection of the board caused by impact of the pick-up nozzle, supporting pins or back-up pins shall be used on the other side of the PCB. The following diagrams show some typical examples of good and bad pick-up nozzle placement:

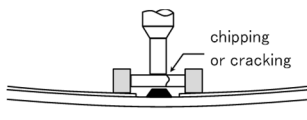
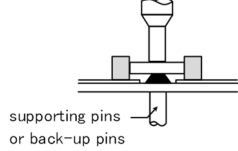
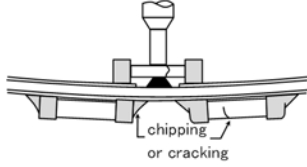
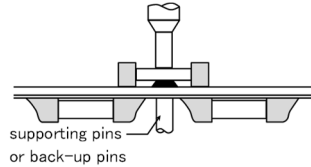
Item	Improper method	Proper method
Single-sided mounting		
Double-sided mounting		

Technical considerations

2. As the alignment pin is worn out, adjustment of the nozzle height can cause chipping or cracking of capacitors because of mechanical impact on the capacitors. To avoid this, the monitoring of the width between the alignment pins in the stopped position, maintenance, check and replacement of the pin shall be conducted periodically.

◆ Selection of Adhesives

Some adhesives may cause IR deterioration. The different shrinkage percentage of between the adhesive and the capacitors may result in stresses on the capacitors and lead to cracking. Moreover, too little or too much adhesive applied to the board may adversely affect components. Therefore, the following precautions shall be noted in the application of adhesives.

- (1) Required adhesive characteristics
 - a. The adhesive shall be strong enough to hold parts on the board during the mounting & solder process.
 - b. The adhesive shall have sufficient strength at high temperatures.
 - c. The adhesive shall have good coating and thickness consistency.
 - d. The adhesive shall be used during its prescribed shelf life.
 - e. The adhesive shall harden rapidly.
 - f. The adhesive shall have corrosion resistance.
 - g. The adhesive shall have excellent insulation characteristics.
 - h. The adhesive shall have no emission of toxic gasses and no effect on the human body.
- (2) The recommended amount of adhesives is as follows:

[Recommended condition]

Figure	2012/3216 case sizes as examples
a	0.3mm min
b	100 to 120 μm
c	Adhesives shall not contact land

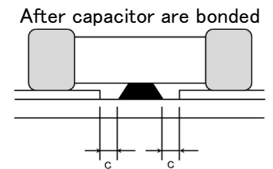
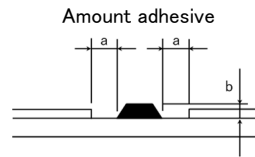

4. Soldering

◆ Selection of Flux

- Since flux may have a significant effect on the performance of capacitors, it is necessary to verify the following conditions prior to use;
- (1) Flux used shall be less than or equal to 0.1 wt% (in Cl equivalent) of halogenated content. Flux having a strong acidity content shall not be applied.
 - (2) When shall capacitors are soldered on boards, the amount of flux applied shall be controlled at the optimum level.
 - (3) When water-soluble flux is used, special care shall be taken to properly clean the boards.

Precautions

◆ Soldering

Temperature, time, amount of solder, etc. shall be set in accordance with their recommended conditions. Sn-Zn solder paste can adversely affect MLCC reliability. Please contact us prior to usage of Sn-Zn solder.

Technical considerations

◆ Selection of Flux

- 1-1. When too much halogenated substance (Chlorine, etc.) content is used to activate flux, or highly acidic flux is used, it may lead to corrosion of terminal electrodes or degradation of insulation resistance on the surfaces of the capacitors.
- 1-2. Flux is used to increase solderability in wave soldering. However if too much flux is applied, a large amount of flux gas may be emitted and may adversely affect the solderability. To minimize the amount of flux applied, it is recommended to use a flux-bubbling system.
- 1-3. Since the residue of water-soluble flux is easily dissolved in moisture in the air, the residues on the surfaces of capacitors in high humidity conditions may cause a degradation of insulation resistance and reliability of the capacitors. Therefore, the cleaning methods

▶ This catalog contains the typical specification only due to the limitation of space. When you consider the purchase of our products, please check our specification. For details of each product (characteristics graph, reliability information, precautions for use, and so on), see our Web site (<http://www.ty-top.com/>).

and the capability of the machines used shall also be considered carefully when water-soluble flux is used.

◆Soldering

- Ceramic chip capacitors are susceptible to thermal shock when exposed to rapid or concentrated heating or rapid cooling.
- Therefore, the soldering must be conducted with great care so as to prevent malfunction of the components due to excessive thermal shock.
- Preheating : Capacitors shall be preheated sufficiently, and the temperature difference between the capacitors and solder shall be within 130°C.
- Cooling : The temperature difference between the capacitors and cleaning process shall not be greater than 100°C.

[Reflow soldering]

【Recommended conditions for eutectic soldering】

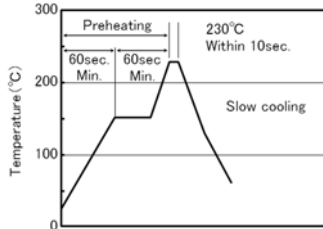

【Recommended condition for Pb-free soldering】

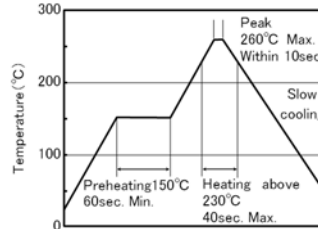

Caution

- ①The ideal condition is to have solder mass (fillet) controlled to 1/2 to 1/3 of the thickness of a capacitor.
- ②Because excessive dwell times can adversely affect solderability, soldering duration shall be kept as close to recommended times as possible. soldering for 2 times.

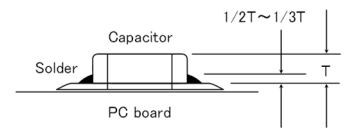

[Wave soldering]

【Recommended conditions for eutectic soldering】

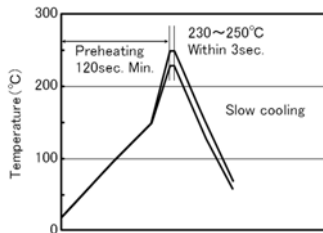

【Recommended condition for Pb-free soldering】

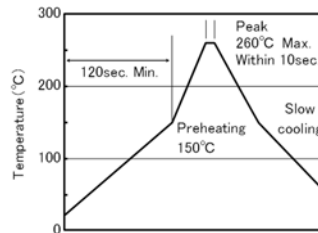

Caution

- ①Wave soldering must not be applied to capacitors designated as for reflow soldering only. soldering for 1 times.

[Hand soldering]

【Recommended conditions for eutectic soldering】

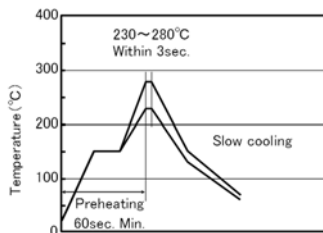

【Recommended condition for Pb-free soldering】

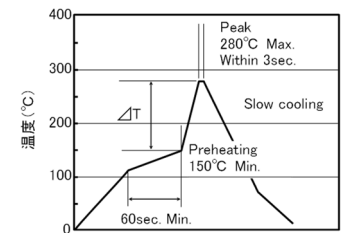
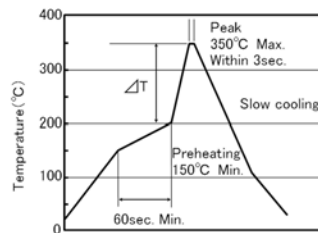

	ΔT
3216type or less	$\Delta T \leq 150^{\circ}\text{C}$

	ΔT
3225type or more	$\Delta T \leq 130^{\circ}\text{C}$

Caution

- ①Use a 50W soldering iron with a maximum tip diameter of 1.0 mm.
- ②The soldering iron shall not directly touch capacitors. soldering for 1 times.

5. Cleaning	
Precautions	<p>◆Cleaning conditions</p> <ol style="list-style-type: none"> When PCBs are cleaned after capacitors mounting, please select the appropriate cleaning solution in accordance with the intended use of the cleaning. (e.g. to remove soldering flux or other materials from the production process.) Cleaning condition shall be determined after it is verified by using actual cleaning machine that the cleaning process does not affect capacitor's characteristics.
Technical considerations	<ol style="list-style-type: none"> The use of inappropriate cleaning solutions can cause foreign substances such as flux residue to adhere to capacitors or deteriorate their outer coating, resulting in a degradation of the capacitor's electrical properties (especially insulation resistance). Inappropriate cleaning conditions (insufficient or excessive cleaning) may adversely affect the performance of the capacitors. In the case of ultrasonic cleaning, too much power output can cause excessive vibration of PCBs which may lead to the cracking of capacitors or the soldered portion, or decrease the terminal electrodes' strength. Therefore, the following conditions shall be carefully checked: Ultrasonic output : 20 W/l or less Ultrasonic frequency : 40 kHz or less Ultrasonic washing period : 5 min. or less

6. Resin coating and mold	
Precautions	<ol style="list-style-type: none"> With some type of resins, decomposition gas or chemical reaction vapor may remain inside the resin during the hardening period or while left under normal storage conditions resulting in the deterioration of the capacitor's performance. When a resin's hardening temperature is higher than capacitor's operating temperature, the stresses generated by the excessive heat may lead to damage or destruction of capacitors. The use of such resins, molding materials etc. is not recommended.

7. Handling	
Precautions	<p>◆Splitting of PCB</p> <ol style="list-style-type: none"> When PCBs are split after components mounting, care shall be taken so as not to give any stresses of deflection or twisting to the board. Board separation shall not be done manually, but by using the appropriate devices. <p>◆Mechanical considerations</p> <p>Be careful not to subject capacitors to excessive mechanical shocks.</p> <ol style="list-style-type: none"> If ceramic capacitors are dropped onto a floor or a hard surface, they shall not be used. Please be careful that the mounted components do not come in contact with or bump against other boards or components.

8. Storage conditions	
Precautions	<p>◆Storage</p> <ol style="list-style-type: none"> To maintain the solderability of terminal electrodes and to keep packaging materials in good condition, care must be taken to control temperature and humidity in the storage area. Humidity should especially be kept as low as possible. <ul style="list-style-type: none"> Recommended conditions Ambient temperature : Below 30°C Humidity : Below 70% RH The ambient temperature must be kept below 40°C. Even under ideal storage conditions, solderability of capacitor is deteriorated as time passes, so capacitors shall be used within 6 months from the time of delivery. <ul style="list-style-type: none"> Ceramic chip capacitors shall be kept where no chlorine or sulfur exists in the air. The capacitance values of high dielectric constant capacitors will gradually decrease with the passage of time, so care shall be taken to design circuits. Even if capacitance value decreases as time passes, it will get back to the initial value by a heat treatment at 150°C for 1hour.
Technical considerations	<p>If capacitors are stored in a high temperature and humidity environment, it might rapidly cause poor solderability due to terminal oxidation and quality loss of taping/packaging materials. For this reason, capacitors shall be used within 6 months from the time of delivery. If exceeding the above period, please check solderability before using the capacitors.</p>

※RCR-2335B (Safety Application Guide for fixed ceramic capacitors for use in electronic equipment) is published by JEITA.

Please check the guide regarding precautions for deflection test, soldering by spot heat, and so on.